



MANUAL

LANTIME M200/WWVB

Network Time Server
with integrated WWVB Receiver

24th April 2014

Meinberg Radio Clocks GmbH & Co. KG

Table of Contents

1	Impressum	1
2	Quick Start	2
3	The Modular System LANTIME	3
4	Network Time Protocol (NTP)	4
4.1	NTP Target	4
4.2	NTP-Client Installation	4
5	General information about WWVB	6
5.1	Code Format	6
6	WWVB Antenna	7
7	Booting the WWVB receiver	8
8	Booting the Single Board Computer	9
9	Configuration User Interface	10
9.1	Introduction: Configuration LANTIME	10
9.2	Root Menu	11
9.3	Menu: Reference Time	13
9.3.1	Version	13
9.3.2	Status	13
9.3.3	Distance to Transmitter	13
9.4	Menu: Time Service	14
9.4.1	Menu: external NTP	14
9.4.2	Menu: Stratum of local clock	14
9.4.3	Menu: Restart NTP	14
9.5	Menu: Network	15
9.5.1	Setup Global Configuration	15
9.5.2	Setup Network Interfaces	16
9.5.3	Setup Network Ipv4 Parameter	16
9.5.4	Menu: Setup Ipv6 Parameter	17
9.5.5	Menu: Link Mode	17
9.5.6	Menu: Setup Network Services	17
9.6	Menu: System	18
9.6.1	Set time zone	18
10	The graphical user interfaces	20
11	The WEB Interface	21
11.1	Configuration: Main Menu	22
11.2	Configuration: Ethernet	23
11.2.1	SYSLOG Server	24
11.3	Network interface specific configuration	25
11.3.1	IPv4 addresses and DHCP	25
11.3.2	IPv6 addresses and autoconf	25
11.3.3	High Availability Bonding	26
11.3.4	Additional Network Configuration	27
11.4	Configuration: Notification	28
11.4.1	Alarm Events	29
11.4.2	E-mail messages	30

11.4.3	Windows Popup Messages	30
11.4.4	SNMP-TRAP messages	30
11.4.5	VP100/NET wall mount display	30
11.4.6	User defined Alarm scripts	30
11.4.7	NTP Client Monitoring	31
11.4.8	Alarm messages	31
11.5	Configuration: Security	32
11.5.1	Password	33
11.5.2	HTTP Access Control	33
11.5.3	SSH Secure Shell Login	33
11.5.4	Generate SSL Certificate for HTTPS	35
11.5.5	NTP keys and certificates	36
11.5.6	SNMP Parameter	36
11.6	Configuration: NTP	37
11.6.1	NTP Authentication	39
11.6.2	NTP AUTOKEY	40
11.7	Configuration: Local	43
11.7.1	Administrative functions	44
11.7.2	User Management	44
11.7.3	Administrative Information	45
11.7.4	Software Update	47
11.7.5	Automatic configuration check	48
11.7.6	Get Diagnostics Information	48
11.7.7	Receiver Information	49
11.7.8	Web interface language	49
11.8	Configuration: Statistics	50
11.8.1	Statistical Information	51
11.9	Configuration: Manual	52
11.10	Configuration: PTP	53
11.10.1	PTPv2 - Global Configuration	54
11.10.2	Option: PTP Client Monitoring	55
11.10.3	PTP Network Configuration	57
11.10.4	PTP State Files	58
12	The Command Line Interface	59
12.1	CLI Ethernet	60
12.2	CLI Notification	62
12.3	CLI Security	64
12.4	CLI NTP Parameter	66
12.4.1	CLI NTP Authentication	67
12.5	CLI Local	67
13	SNMP Support	70
13.1	Configuration over SNMP	71
13.1.1	Examples for the usage of the SNMP configuration features	72
13.1.2	Further configuration possibilities	73
13.1.3	Send special timeserver commands with SNMP	73
13.1.4	Configuration of the timeserver with SNMP: Reference	75
13.2	SNMP Traps	80
13.2.1	SNMP Trap Reference	80
14	Attachment: Technical Information	81
14.1	Skilled/Service-Personnel only: Replacing the Lithium Battery	81
14.2	Technical Specifications M200 Slimline Desktop	81
14.3	Safety instructions for building-in equipment	82
14.3.1	CE-Label	82
14.4	Rear Panel Connectors	83
14.5	TERMINAL (Console)	83
14.6	Technical specifications WWVB5xx	84
14.7	Technical Specifications LAN CPU	85
14.7.1	Rear Connector Pin Assignments LAN CPU	86

14.7.2 VGA, Keyboard Connector Pin Assignments	86
14.8 Manual VP100/NET Display configuration	87
14.9 Global Configuration File	89
14.10Global Option File	91
14.11USB Stick	92
14.11.1 Menu Structure	92
14.11.2 Menu Configuration Files	92
14.11.3 Menu Script Files	93
14.11.4 Keypad locking	93
14.12Third party software	94
14.12.1 Operating System GNU/Linux	94
14.12.2 Samba	94
14.12.3 Network Time Protocol Version 4 (NTP)	95
14.12.4 mini_httpd	96
14.12.5 GNU General Public License (GPL)	97
14.13Reference	101

1 Impressum

Meinberg Radio Clocks GmbH & Co. KG
Lange Wand 9, 31812 Bad Pyrmont - Germany

Phone: + 49 (0) 52 81 / 93 09 - 0
Fax: + 49 (0) 52 81 / 93 09 - 30

Internet: <http://www.meinberg.de>
Mail: info@meinberg.de

Date: 2009-08-20

2 Quick Start

When booting the system the following message will be displayed while dots will be counted up in the lower line:

```
Starting up           please wait...
.....
```

Main Menu will be displayed with some important status informations after booting has finished:

```
WWVB: NORMAL OPERATION  Fri, 15.12.2008
NTP: not sync           UTC 09:12:11
```

If the WWVB receiver remains asynchronous (Ref.Time LED is still red after 3 minutes) the field value has to be checked (press buttons \downarrow and *OK* from main menu). The antenna has to be installed so that the longer side points to the location of the WWVB transmitter in Fort Collins - Colorado.

```
REF STATE:  State: sync
             FIELD: 94
```

For first time installation enter TCP/IP address, netmask and default gateway. To get an overview of the current configuration press F2 from main menu. Press F2 again to enter SETUP configuration page. Please ask your administrator for proper TCP/IP configuration:

```
Global Cfg.      Services
-> Interfaces  <-
```

Then press 3 times the OK button to change to IPV4 ETH0 configuration page to enter the IP address, netmask and the default gateway:

```
SETUP:      Ipv4 LAN Parameter ETH0
Ipv4        ADDRESS: 192.168.10.200
```

After this all further settings can be done via network interface, either by using a WEB browser or a Telnet Session.

Default user: root

Default password: timeserver

3 The Modular System LANTIME

The LANTIME M200 includes a reference clock, a single-board computer SBC LX800 500 MHz with integrated network card, and a power supply unit, all installed in a metal desktop case and ready to operate. The interfaces provided by the LANTIME are accessible via connectors in the rear panel of the case.

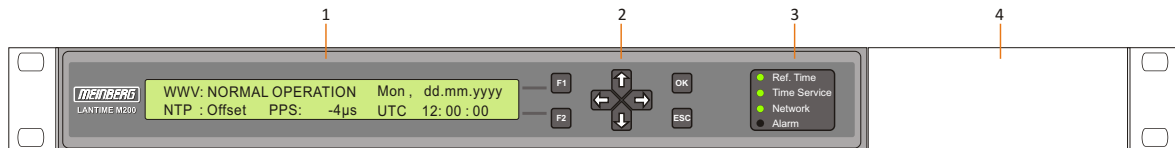

1. LCD Display
2. Function buttons: 4-way navigation button; F1, F2, OK, ESC
3. Status LEDs: Ref. Time, Time Service, Network, Alarm
4. Optional brackets for rack mount installations

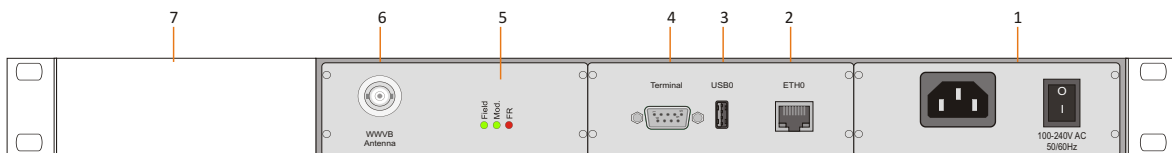

1. Power supply connector (see chapter power supply)
2. Network connector ETH0 10/100 Mbit RJ45.
3. USB connector
4. Serial COM port, RS232 Time String output
5. 3 x LED: Field - Fieldstrength
Mod. - Modulation
FR - Free Run
6. WWVB - Antenna, BNC
7. 19" Mounting Rack

The implemented NTPD distributes the reference time from the receiver. Information on the NTPD is monitored on the LC display or can be inquired via the network.

The installation of LANTIME is very easy for the system/network administrator. The network address, the netmask and the default gateway have to be configured from the front panel of LANTIME. The network address or the equivalent name of LANTIME has to be shown to all NTP clients in the TCP/IP network.

As well as NTP the Linux system also supports a number of further network protocols: HTTP(S), FTP, SSH and Telnet. Because of this remote configuration or status requests can come from any WEB browser. This access via the network can be deactivated. Changes in the receiver status, errors or other important events are logged either on the local Linux system or on an external SYSLOG-Server. In addition messages can be sent to a data center via SNMP traps or automatically generated e-mails where they can be recorded. Furthermore all alarm messages can be displayed by the large display VP100/20/NET that is accessed via network connection. In order to avoid a service interruption several LANTIME NTP servers can be installed in the same network to obtain redundancy.

4 Network Time Protocol (NTP)

NTP is a common method for the synchronization of hardware clocks in local and global networks. The basic concept, version 1 [Mills88], was published in 1988 as RFC (Request For Comments). Experiences acquired from its practical use on the Internet was followed by version 2 [Mills89]. The NTP software package is an implementation of the actual version 3 [Mills90], based on the specification RFC-1305 from 1990 (directory doc/NOTES). Permission to use, copy, modify and distribute this software for any purpose and without fee is hereby granted (read File COPYRIGHT).

NTP operates in a way that is basically different from that of most other timing protocols. NTP does not synchronize all connected clocks; instead it forms a hierarchy of timeservers and clients. Each level in this hierarchy is called a stratum, and Stratum 1 is the highest level. Timeservers at this level synchronize themselves by means of a reference time source such as a radio controlled clock, satellite receiver or modem time distribution. Stratum 1 Servers distribute their time to several clients in the network which are called Stratum 2.

Highly precise synchronization is feasible because of the several time references. Every computer synchronizes itself with up to three valued time sources. NTP enables the comparison of the hardware times and the adjustment of the internal clock. A time precision of 128 ms, and often better than 1 ms, is possible.

4.1 NTP Target

The NTP software package was tested on different UNIX systems. Many UNIX systems have an NTP client pre-installed. Only some basic configurations need to be done (/etc/ntp.conf). NTP clients as freeware or shareware are also available for most other operating systems like Windows 7/Vista/XP/NT/2000/98/95/3x, OS2 or MAC. The following WEB site is recommended to get the latest version of NTP:
<http://www.ntp.org>

You can find more information on our web page at: <http://www.meinberg.de/english/sw/ntp.htm>

4.2 NTP-Client Installation

The following example shows the installation of a NTP client under UNIX. First make sure that there is no NTP installed on your computer because many UNIX operating systems include NTP already.

The shipped source code of the NTP daemon has to be compiled on the target system. Using the enclosed script file configures the compilation of the NTP daemon and all tools.

configure

All necessary information from the system will be collected and the corresponding make files will be generated in the subdirectories.

After that the NTP daemon and all needed utilities will be generated. Therefore type:

make

While compiling the NTP daemon several warnings may appear. These warnings are mostly unimportant. In case of problems during the compilation read the system dependent notes in the subdirectory 'html'.

Afterwards the generated programs and tools have to be moved in the corresponding directories. Therefore type:

make install

The time adjustment can occur in different ways. Either the system time can be set once by using the tool "ntpdate lantime" or the NTPD daemon is started. In the first case it is recommended to set the time automatically with "cron" or once when booting the system. The second case is described below.

First a file named `/etc/ntp.conf` has to be generated with an editor. Adapting the file to Meinberg LANTIME it should contain the following:

```
# Example for /etc/ntp.conf for Meinberg LANTIME
server 127.127.1.0          # local clock
server 172.16.3.35        # TCPIP address of LANTIME
# optional: Driftfile
# driftfile /etc/ntp.drift
# optional: activate all messages in syslogfile
# logconfig =all
```

The NTP daemon is started with `'ntpd'` or, using `'rc.local'`, while booting the system. Status messages during operation are saved in `/var/adm/messages` and `/var/adm/syslog` (corresponding to the syslog configuration).

e.g.: tail /var/log/messages

Shows the last lines from the file `messages`. The status messages can also be redirected in a log file by using the following option:

ntpd -llogfile

The command `'ntpq'` in the directory `ntpq` requests the actual status of the NTP daemon (see also `doc/ntpq.8`).

e.g.: ntpq/ntpq

An interpreter appears; Type `"?"` for a list of all available commands. The command `'peer'` is used to list all active reference clocks:

remote	refid	st	t	when	poll	reach	delay	offset	jitter
LOCAL(0)	LOCAL(0)	3	l	36	64	3	0.00	0.000	7885
lantime	.GPS.	0	l	36	64	1	0.00	60.1	15875

with the following meaning:

- remote: list of all valid time servers (`ntp.conf`)
- refid: reference number
- st: actual stratum value (hierarchy level)
- when: last request (seconds)
- poll: period of requesting the time server (seconds)
- reach: octal notation of the successful requests, shifted left
- delay: delay of the network transmission (milliseconds)
- offset: difference between system time and reference time (milliseconds)
- jitter: variance of the offsets (milliseconds)

Repeatedly `'peer'` commands lets the user observe the accuracy of the NTP daemon. Every 64 seconds (value of `-poll`) a new time string is read in from the radio clock. The NTP daemon needs approx. 3...5 minutes for initialisation. This is indicated by a wildcard (`*`) on the left side of the remote name.

The NTP daemon terminates itself if the system time differs from the UTC time by more than 1024 seconds. This often happens when the time zone is not correctly set (see also system manual `"zic"` or `"man zic"`).

5 General information about WWVB

NIST radio station WWVB is located near Fort Collins, Colorado, on the same site as station WWV. The WWVB broadcast is used by millions of people throughout North America to synchronize consumer electronic timing products such as wall clocks, clock radios, and wristwatches. In addition, WWVB is used for high level applications including network time synchronization and frequency calibration. The WWVB transmission is maintained by the National Institute of Standards and Technology (NIST).

WWVB continuously broadcasts a time and frequency signal at 60 kHz. The carrier frequency provides a stable frequency reference traceable to the national standard. There are no voice announcements on the station, but a time code is synchronized with the 60 kHz carrier and broadcast continuously at the rate of 1 bit per second using pulse width modulation. The carrier power level is modulated to encode the time data. The carrier power is reduced by 17 dB at the start of each second, so that the leading edge of every negative going pulse is on time. Full power is restored 0.2 s later for a binary #0#, 0.5 s later for a binary #1#, or 0.8 s later to convey a position marker. The binary coded decimal (BCD) format is used, which combines binary digits to represent decimal numbers. The time code contains the year, day of year, hour, minute, second, and flags that indicate the status of Daylight Savings Time, leap year, and leap seconds. WWVB identifies itself by advancing its carrier phase 45 degrees at 10 minutes after the hour and returning to normal phase at 15 minutes after the hour. If you plot WWVB phase, this results in a phase step of approximately 2.08 microseconds.

5.1 Code Format

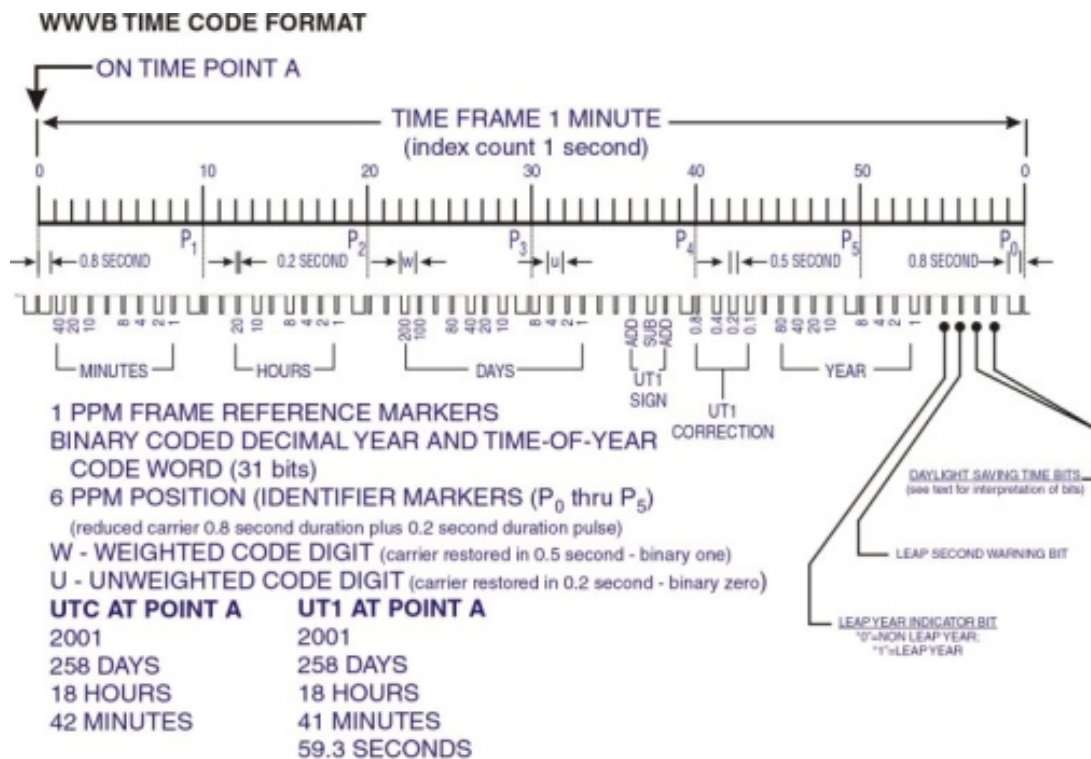

6 WWVB Antenna

The antenna of WWVB receivers (AW02-60) includes a ferrite rod which must be aligned to the transmitter. The antenna should be installed with a distance of at least 30cm to all metal objects because they would detune the antenna resonance. A distance of several meters to computer monitors must be kept. If they are running in a high screen resolution mode, their line frequency is close to the carrier frequency of the WWVB transmitter, which would cause a worse or no reception.



The antenna has to be mounted as exactly as possible. Turning it out of the main receive direction will result in less accurate time frames. The antenna must be placed in longitudinal direction to the WWVB-transmitter (Fort Collins - Colorado).

7 Booting the WWVB receiver

The LINUX operating system is loaded from a packed file on the flash disk of the single board computer to a RAM disk. All files of the flash disk are stored in the RAM disk after booting. Because of that it is guaranteed that the file system is in a defined condition after restart. This boot process takes approx. one minute.

After starting up the LINUX system the network function is initiated and the program for communication with the WWVB receiver and the NTPD (NTP daemon) is started. After that NTPD starts synchronization with the reference clocks (usual the hardware clock of the single board computer and the WWVB receiver).

For the synchronization of the NTPD with the WWV5xx it is necessary that the WWVB receiver is synchronous with the WWVB time.

Because of the internal time of the NTP which is adjusted by a software PLL (phase locked loop) it takes a certain time to optimize this offset. The NTPD tries to keep the offset below ± 128 ms; if the offset becomes to large the system time is set with the WWVB time. Typically values for the offset are ± 5 ms after the NTPD has already synchronized.

```
REF STATE: State: sync
           FIELD: 94
```

8 Booting the Single Board Computer

The LINUX operating system is loaded from a packed file on the flash disk of the single board computer to a RAM disk. All files of the flash disk are stored in the RAM disk after booting. Because of that it is guaranteed that the file system is in a defined condition after restart. This boot process takes approx. one minute. After the LINUX system has started up already the network function is initiated and the daemon software LANTIME is started.

```
Starting up           please wait...  
.....
```

After starting up the LINUX system the network function is initiated and the program for communication with the WWVB AM5xx and the NTPD (NTP daemon) is started. After that NTPD starts synchronization with the reference clocks (usual the hardware clock of the single board computer and the WWVB receiver). Until synchronization is finished the following message is displayed:

```
WWV: NORMAL OPERATION  Fri, 15.12.2008  
NTP: not sync          UTC 09:12:11
```

For the synchronization of the NTPD with the WWVB5xx it is necessary that the WWVB receiver is synchronous with the WWVB time. In this case the following message is monitored on the display:

```
WWV: NORMAL OPERATION  Fri, 15.12.2008  
NTP: Offset PPS: 1ms   UTC 09:14:16
```

The second line shows the user that the NTPD is synchronized with the WWVB receiver with an offset of 1 ms. Because of the internal time of the NTP which is adjusted by a software PLL (phase locked loop) it takes a certain time to optimize this offset. The NTPD tries to keep the offset below ± 128 ms; if the offset becomes too large the system time is set with the WWVB time. Typically values for the offset are ± 5 ms after the NTPD has already synchronized.

9 Configuration User Interface

9.1 Introduction: Configuration LANTIME

There are several ways to configure the LANTIME parameters:

- Command Line Interface (CLI) via TELNET
- Command Line Interface via SSH
- Command Line Interface via serial terminal in front panel
(38400/8N1/VT100)
- HTTP Interface
- Secure HTTP Interface (HTTPS)
- Front panel LCD/VFD Interface
- SNMP Management

In order to be able to configure the time server via the web interface or a telnet/SSH connection, an IP address has to be assigned via the front panel keys and LC/VF display (for automatic assignment possibilities please refer to: DHCP IPv4 or AUTOCONF IPv6). LANTIME variants without a display can be configured using the serial terminal interface (labeled "Term" or "Terminal") The termin program should be set to 38400Baud / 8N1 – VT100 emulation. Once the IPv4 address, net mask and IPv4 GATEWAY have been set up or the network interface has been automatically configured with DHCP/Autoconf, further configuration changes can be done via a network connection:

To set up a TELNET connection the following commands are entered:

telnet 198.168.10.10 // LANTIME IP address

user: root

password: timeserver

With "setup" the configuration program is started.

To set up a SSH connection the following commands are entered:

ssh root@198.168.10.10 // LANTIME IP address

password: timeserver

With "setup" the configuration program is started.

To set up a HTTP connection the following address is to enter in a web browser:

http://198.168.10.10 // LANTIME IP address

password: timeserver

To set up a Secure HTTP (HTTPS) connection the following address is entered in a web browser:

https://198.168.10.10 // LANTIME IP address

password: timeserver

9.2 Root Menu

The root menu is shown when the receiver has completed initialization after power-up. With the four arrow buttons and the buttons „OK“, „ESC“, „F1“ and „F2“ the navigation and setting of parameters can be managed. Main menu can be reached by pressing „ESC“ some times. The main menu reflect some of the main parameters of the time server.

First line displays the status of the reference clock. After the start-up, the Lantime is not synchronized and the text "NOT SYNC" is displayed. If the text "NORMAL OPERATION" appears, the system is already synchronized. If the antenna is disconnected or not working properly, the text "NOT AVAILABLE" is displayed instead.

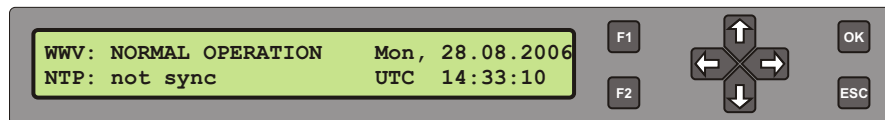

Current time and date of the timeserver with the name of the time zone (NTP uses UTC time zone) will be monitored on the right side. The multicolor LEDs will reflect the current state of the device:

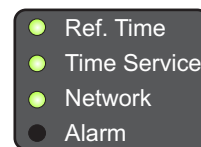

„Ref. Time“

green: the reference clock (e.g. integrated WWVB5xx) produce valid time.
red: the reference clock produce no valid time (e.g. not synchronized)

„Time Service“

green: NTP has been synchronized to reference clock.
red: NTP is not synchronous to reference clock or sync to „local clock“

„Network“

green: all watched network ports has been “link up“ detected
red: at least one of the watched network ports (look at „Setup Device Parameter / Check Network Linkup“) is not connected

„Alarm“

off: no error at moment
ret: general error – more information will be shown on display.

When pressing the „OK“ button from main menu the version of the LANTIME software, the NTP and the LINUX kernel version will be displayed.

```
TYP:ELX800 WWVB511 M3x V5.28 2.6.12
SN:030100000000 NTP: 4.2.0
```

The following main menus will be displayed when pressing the „UP“ and „DOWN“ arrow buttons:

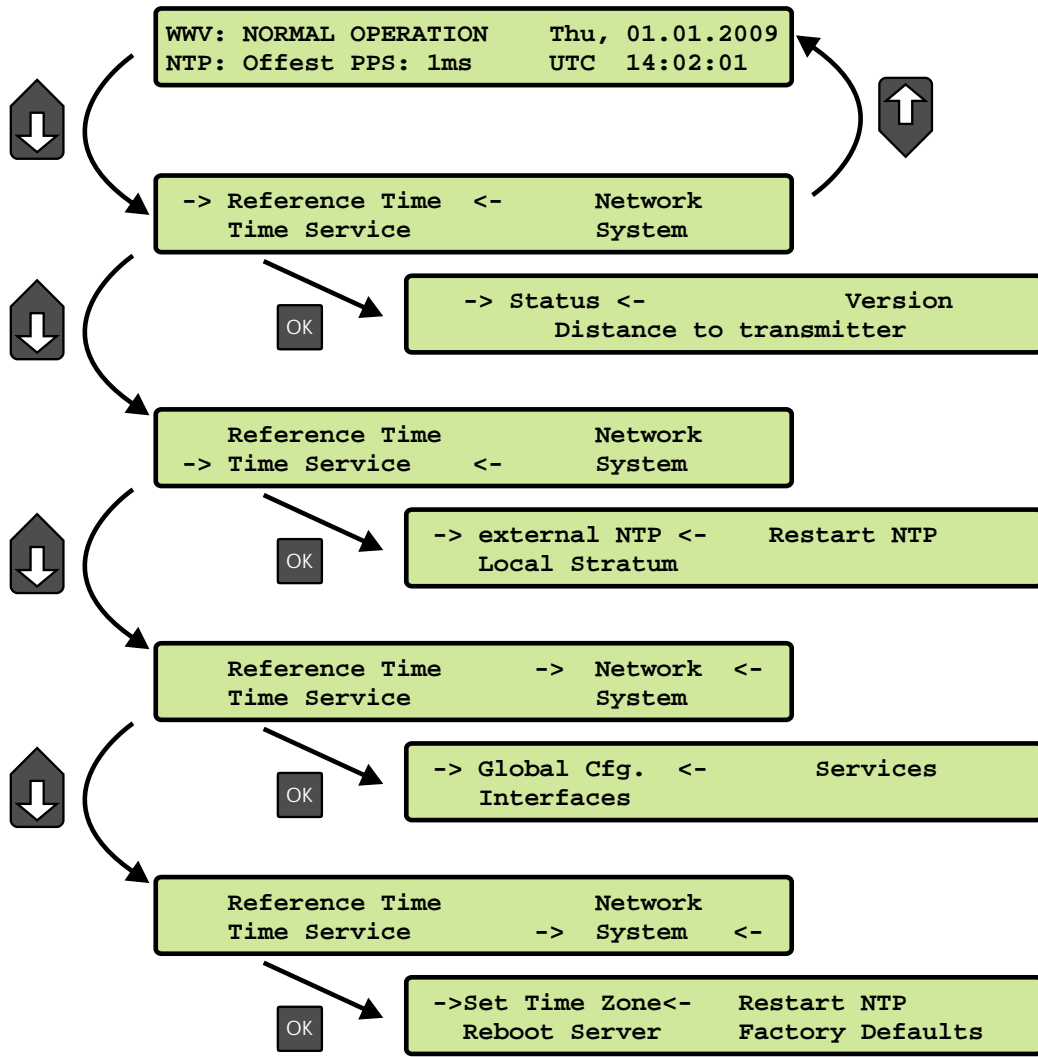

9.3 Menu: Reference Time

The NTP configuration page is used to set up the additional NTP parameters needed for a more specific configuration of the NTP subsystem.

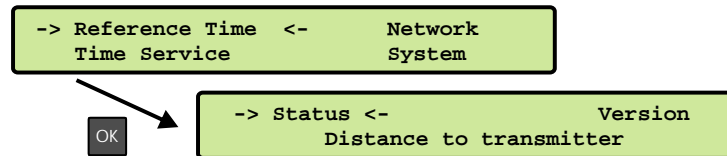

For entering the sub menus press the "OK" or right arrow button.

9.3.1 Version

```
Reference Clock WWV511 State: SYNC
WWV511 v1.00 S/N:001510000000
```

This first menu will monitor the current state ("sync" or "not sync"). The next line will reflect the version number, the serial number of the WWVB511 and the oscillator type, if available.

9.3.2 Status

```
WWV STATE: State: SYNC
FIELD: 100
```

The "Field" parameter will display the digitized value of the field strength in this menu. There is a logarithmic relation between this value and the field strength. This menu is useful for mounting the antenna. The antenna has to be installed with the longer side to direction of the WWVB transmitter in Fort Collins - Colorado.

9.3.3 Distance to Transmitter

```
Setup: WWVB Receiver Position
Distance to Transmitter: 1200km
```

The receiver position is configured in the menu "DISTANCE TO TRANSMITTER" for compensating the propagation delay of the received long wave signal. This setting should be done as exact as possible (in kilometers), because the absolute offset of the time frame is influenced by this value.

9.4 Menu: Time Service

The NTP configuration page is used to set up the additional NTP parameters needed for a more specific configuration of the NTP subsystem.

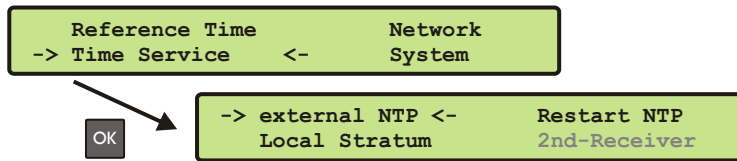

9.4.1 Menu: external NTP

The default configuration of the timeserver consists of a local clock, which represents the hardware clock of your LANTIME system and the GPS reference clock. The local clock is only chosen as the NTP time reference after the GPS clock lost its synchronization. The stratum level of this local clock is set to 12, this ensures that clients recognize the switchover to the local clock and are able to eventually take further actions. The local clock can be disabled if the timeserver should not answer anymore when the reference clock is out of order.

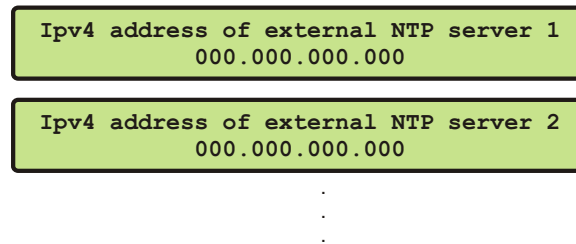

Seven additional external NTP servers can be set up to provide a high grade of redundancy for the internal reference clock.

9.4.2 Menu: Stratum of local clock

The local clock is only chosen as the NTP time reference after the GPS clock lost its synchronization. The stratum level of this local clock is set to 12, this ensures that clients recognize the switchover to the local clock and are able to eventually take further actions. The local clock can be disabled if the timeserver should not answer anymore when the reference clock is out of order. The field "Stratum of local clock" is used to change the stratum level of the local clock (see above), default is 12.

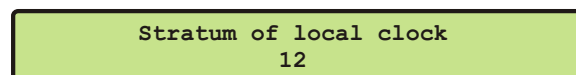

9.4.3 Menu: Restart NTP

If the time of the reference clock has changed (e.g. while testing with different times) the system time has to be set with the time of the reference clock and the NTP has to be restarted.

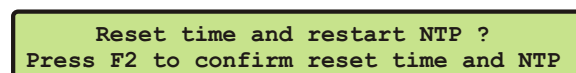

9.5 Menu: Network

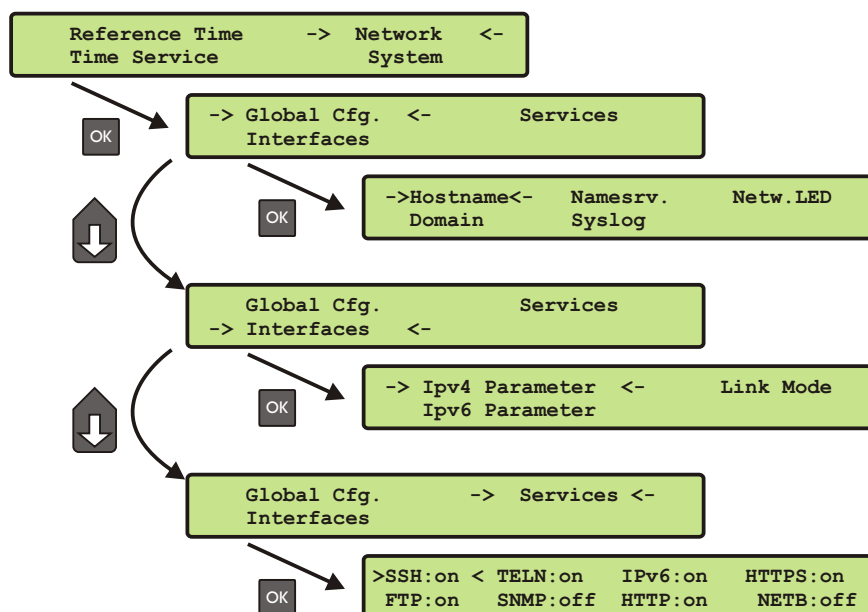

In this submenu the network configuration parameters related to the network interfaces can be changed. The submenus can be selected with the arrow keys and the “OK” button:

As soon as an IP address is configured, additional network configuration can be done via network connection with TELNET, SSH or the WEB interface. Ask your network administrator for network specific parameters. Every change of the network parameters will restart the NTP. All network specific parameters will be saved on the flash disk (/mnt/flash/config/global_configuration) and will be reloaded after reboot. It is highly recommended not to edit this file manually but to configure the parameters via the several configuration interfaces (HTTP, CLI or SNMP). If this file is not present, an empty file will be created. See Appendix for the default settings of this file.

9.5.1 Setup Global Configuration

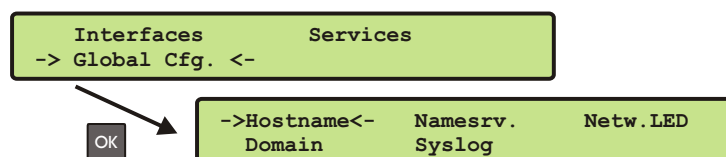

In this sub menu you can change the global network settings like host and domain name, nameserver and syslog server. Further name- or syslog servers can be set up via HTTP interface or CLI Setup. In the nameserver and syslog server fields you have to enter an Ipv4 address.

All information written to the LANTIME SYSLOG `/var/log/messages` can be forwarded to one or two remote SYSLOG servers. The SYSLOG daemon of this remote SYSLOG needs to be configured to allow remote systems to create entries. A Linux SYSLOG daemon can be told to do so by using the command `'syslogd -r'` when starting the daemon. If you enter nothing in the SYSLOG server fields or specify 0.0.0.0 as the SYSLOG servers addresses, the remote SYSLOG service is not used on your LANTIME.

Please be aware of the fact that all SYSLOG entries of the timeserver are stored in `/var/log/messages` and will be deleted when you power off or reboot the timeserver. A daily CRON job is checking for the size of the LANTIME SYSLOG and deletes it automatically if the log size is exceeding a certain limit.

By specifying one or two remote SYSLOG servers, you can preserve the SYSLOG information even when you need to reboot or switch off the LANTIME.

```

SETUP: Check Network LinkUp on LAN Ports
ETH0:x  ETH1:  ETH2:  ETH3:  PTP0:
  
```

The submenu "Netw. LED" will monitor the network ports, which will be checked continuously if the network port is "LINKED UP". If one of these ports has no link up, the network LED on the front panel will change to red. An "L" for "LED" indicates if the port is checked. Please navigate through the list of ports with the LEFT/RIGHT buttons and change the setting with the UP/DOWN buttons.

9.5.2 Setup Network Interfaces

In the network configuration parameters related to the network interfaces can be changed. The following sub-menus can be selected with the arrow keys and the "OK" button:

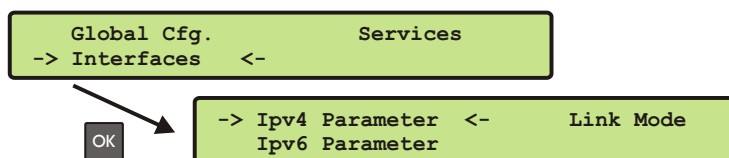

When configured an IP address once additionally network configuration can be done via network connection with TELNET, SSH or the WEB interface. Ask your network administrator for network specific parameters. Every change of the network parameters will restart the NTP. All network specific parameters will be saved on the flash disk (/mnt/flash/config/global_configuration) and will be reloaded after reboot.

9.5.3 Setup Network Ipv4 Parameter

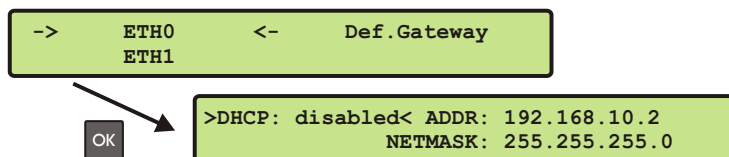

There is a separate configuration submenu for every physical network interface. If there is no DHCP client mode activated a static IP address for each interface can be entered. IPv4 addresses are built of 32 bits which are grouped in four octets, each containing 8 bits. You can specify an IP address in this mask by entering four decimal numbers, separated by a point ".".

Example: 192.168.10.2

Additionally you can specify the IPv4 netmask and your default gateway address. Please contact your network administrator, who can provide you with the settings suitable for your specific network.

If there is a DHCP (Dynamic Host Configuration Protocol) server available in your network, the LANTIME system can obtain its IPv4 settings automatically from this server. If you want to use this feature (again, you should ask your network administrator whether this is applicable in your network), you can change the DHCP Client parameter to "ENABLED". Using DHCP is the default factory setting.

If the DHCP client has been activated, the automatically obtained parameters are shown in the appropriate fields (IPv4 address, netmask, gateway).

9.5.4 Menu: Setup Ipv6 Parameter

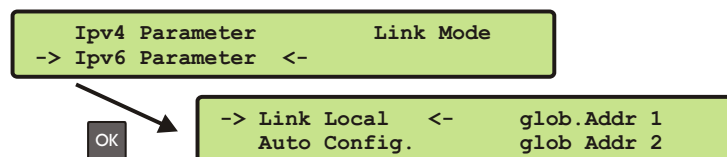

The IPv6 parameters can be configured via the front panel display for the first ethernet port (ETH0) only. Additional IPv6 configuration can be done via network connection with TELNET, SSH or the WEB interface.

You can specify up to three IPv6 addresses for your LANTIME timeserver (two via front panel display and another one via WEB interface). Additionally you can switch off the IPv6 autoconf feature. IPv6 addresses are 128 bits in length and written as a chain of 16 bit numbers in hexadecimal notation, separated with colons. A sequence of zeros can be substituted with "::" once.

If you enabled the IPv6 protocol, the LANTIME always gets a link local address in the format "fe80:: ...", which is based upon the MAC address of the interface. If a IPv6 router advertiser is available in your network and if you enabled the IPv6 autoconf feature, your LANTIME will be set up with up to three link global addresses automatically.

9.5.5 Menu: Link Mode

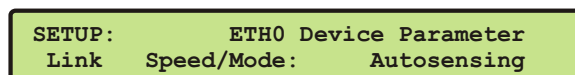

The parameters for speed and link mode of the net card can be changed with the menu item „Link Mode“. There are 5 modes available: Autosensing, 10 MBit/Half-Duplex, 100 MBit/Half-Duplex, 10 MBit/Full-Duplex, 100 MBit/Full-Duplex. Default setting is Autosensing.

9.5.6 Menu: Setup Network Services

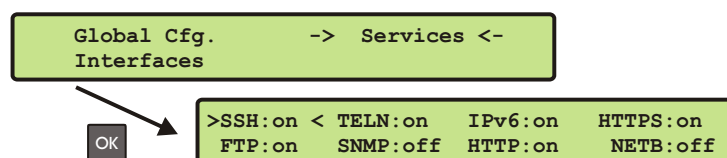

The possible network protocols and access methods can be configured. After pressing the OK button you can enable/disable SSH, TELNET, SNMP, FTP, IPV6, HTTP, HTTPS and NETBIOS by using the UP/DOWN Keys and navigate through the list with the LEFT/RIGHT keys. After you saved your settings with the "OK" button, all these subsystems are stopped and eventually restarted (only if they are enabled, of course).

9.6 Menu: System

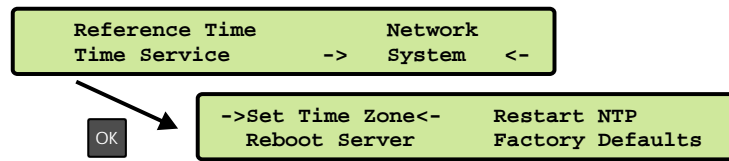

In this submenu system specific parameters can be configured:

- With **Set time zone** the time zone displayed on the front panel display can be configured (see below).
- With **Restart NTP** you can stop the currently running NTP daemon and restart it afterwards.
- The command **Reboot time server** reboots the Linux operating system – the build-in reference clock will not be restarted.
- When **Reset to factory defaults** is called, all system parameters will be reset to initial values. However the parameters of each network interface do not change.

9.6.1 Set time zone

The time zone of the time that is shown on the front panel display can be set up here. The internal time zone of the timeserver and the time of NTP will always be UTC. These parameters will not affect the serial output lines and the timecode (IRIG) outputs. These parameters have to be configured in another menu (Reference Time->Setup Outputs)

This menu lets the user enter the names of the local time zone with daylight saving disabled and enabled, together with the zones' time offsets from UTC. The left part of the display shows the zone and offset if daylight saving is off whereas the right part shows name and offset if daylight saving is on. These parameters are used to convert UTC to local time, e.g. MEZ = UTC + 1h and MESZ = UTC + 2h for central Europe. The range of date daylight saving comes in effect can be entered using the next two topics of the setup menu.

```

DAYLIGHT SAVING OFF: |MEZ | +01:00h
DAYLIGHT SAVING ON : |MESZ | +02:00h
  
```

These two topics let the user enter the range of date for daylight saving to be in effect. Concerning parameter input both topics are handled identically, so they are described together in this chapter. Beginning and ending of daylight saving may either be defined by exact dates for a single year or using an algorithm which allows the receiver to re-compute the effective dates year by year. The figures below show how to enter parameters in both cases. If the number of the year is displayed as wildcards (^*), a day-of-week must be specified. Then, starting from the configured date, daylight saving changes the first day which matches the configured day-of-week. In the figure below March 25, 1996 is a Saturday, so the next Sunday is March 31, 1996.

All changeover rules for the daylight saving like "the first/the second/the second to last/the last Sunday/Monday etc. in the x-th month," can be described by the used format "first specified day-of-week after a defined date".

If the number of the year is not displayed as wildcards the complete date exactly determines the day daylight saving has to change (March 31, 1996 in the figures below), so the day-of-week does not need to be specified and therefore is displayed as wildcards.

```

DAYLIGHT SAV ON      Date: 25.03.****
Day of Week: Sun     Time: 02:00:00
  
```

```
DAYLIGHT SAV ON      Date: 31.03.1996
Day of Week: ***     Time: 02:00:00
```

```
DAYLIGHT SAV OFF    Date: 25.10.****
Day of Week: Sun     Time: 03:00:00
```

```
DAYLIGHT SAV OFF    Date: 25.03.1996
Day of Week: Sun     Time: 03:00:00
```

If no changeover in daylight saving is wanted, identical dates and times must be entered in both of the sub menus. In addition identical offsets for DAYLIGHT SAV ON/OFF should be configured in the sub menu TIMEZONE. After this a restart should be done.

10 The graphical user interfaces

The LANTIME offers three different options for configuration and status management: Web interface, Command Line Interface Setup and SNMP. In order to use the SNMP features of your LANTIME, you need special software like management systems or SNMP clients. In order to use the web interface, all you need is a web browser (LANTIME supports a broad range of browsers).

Lantime configuration utility 1.01

Lantime: MGX V4.07 **S/N:** n/a
Host: LanGpsV4 **IPv4:** 172.16.3.226
Domain: py.meinberg.de **IPv6:** fe80::2e0:4bff:fe06:746d/10 (Linklocal)

GPS Status: Normal Operation **Uptime:** 1:08
NTP Status: Offset PPS: 2µs
Receiver information: sync; 51.9834° 9.2260° 174m; 10/11SVs

Last messages:
 20.04.04 08:44:15 UTC: lantime -> NTP sync to PPS
 20.04.04 08:40:03 UTC: lantime -> NTP sync to GPS
 20.04.04 08:36:42 UTC: lantime -> lantime rebooted

Configuration & Management:
 Ethernet Notification Security NTP Local Statistic Manual Logout

Meinberg Funkuhren Contact Internet
 Auf der Landwehr 22 Phone: 49 (0) 52 81 / 93 09 - 0 Homepage: http://www.meinberg.de
 D - 31812 Bad Pyrmont, Germany Fax: 49 (0) 52 81 / 93 09 - 30 Email: info@meinberg.de

LANTIME CONFIGURATION UTILITY 1.01

Lantime: MGX/GPS 19"/1U V4.05 **S/N:** n/a
Host: LanGpsV4 **Uptime:** 4:45
Domain: py.meinberg.de **Notification:** DISABLED

IPv4: 172.16.3.227 **IPv6:** fe80::2e0:4bff:fe04:c240/10 (LL)

GPS STATUS: Normal Operation **Date:** Fri, 26.03.2004
NTP STATUS: Offset PPS: 5µs **Time:** 13:14:47

Receiver information: sync; 51.9835° 9.2260° 179m; 8/9SVs

Last Messages:
 26.03.04 08:38:41 UTC: lantime -> NTP sync to PPS
 26.03.04 08:34:15 UTC: lantime -> NTP sync to GPS
 26.03.04 08:33:19 UTC: lantime -> NTP sync to local
 26.03.04 08:29:54 UTC: lantime -> lantime rebooted

Configuration & Management:
 Ethernet Notification Security nTp Local eXit

In addition to the SNMP and web interface, you can also manage your LANTIME configuration via a command line interface (CLI), which can be used via a TELNET or SSH connection. A setup tool can be started after login, just type "setup" and press ENTER at the prompt.

There are only a few differences between the web interface and the CLI, most options are accessible from both interfaces (the CLI has no statistical functions).

The above screen shots show the web interface and the Command Line Interface setup tool. The CLI setup tool cannot be used by more than one user at a time, the web interface can be used by more than one user in parallel, but the two or more running sessions may influence each other. We explicitly do not recommend the parallel usage of the configuration interfaces.

11 The WEB Interface

Connect to the web interface by entering the IP of your LANTIME into the address field of your web browser:

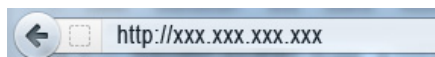

If you want to use an encrypted connection, replace the http:// with https:// in the above address. You may be prompted to accept the SSL certificate of your LANTIME the first time you are connecting to the system via HTTPS. In both HTTP and HTTPS mode, you will see the following login screen:

GPS controlled NTP time server

GPS:	NORMAL OPERATION	Time:	UTC 09:58:53
NTP:	Offs. PPS:-1us	Date:	Wed, 29.04.2009
Host:	LantimeV5	IP:	172.16.3.209
Contact:	Meinberg	Location:	Germany

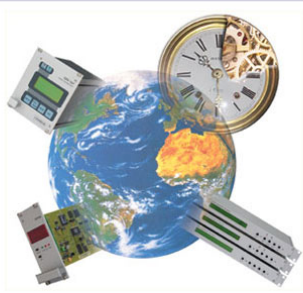

Login for configuration and statistic

User:

Password:

On this start page you see a short status display, which corresponds with the LC display on the front panel of the LANTIME unit. The upper line shows the operation mode of the receiver.

In the upper right corner of the LC display the time and time zone can be found, below that you will find the date and day of the week. On the second line the systems reports the NTP status. During the initial synchronisation process a "NTP: not sync" indicates that the NTP system is not synchronised with the receiver, this can also appear if the receiver loses synchronisation and the NTP switches back to its "LOCAL CLOCK" time source.

The receiver is connected to the LANTIME system internally by using a serial connection and additionally by using the second pulse. There are therefore 2 references used by NTPD, the receiver (GPS, PZF,...) and PPS time source. You will find the two time sources in the status information of the NTPD. After the NTP is synchronised, the display shows "NTP: Offset GPS [PZF,MSF,WWV,TCR]: x" or "NTP: Offset PPS: x" where "x" is the actual offset to the receiver or PPS time source.

This page will be reloaded every 30 seconds in order to reflect the current status of the unit. Please bear this in mind when you try to login and enter your password. If you do not press ENTER or the Login button within 30 seconds, the user and password field is cleared and you have to start over again.

Login first installation:

Default User: *root*

Default Password: *timeserver*

11.1 Configuration: Main Menu

After entering the right password, the main menu page shows up. This page contains an overview of the most important configuration and status parameters for the system.

MEINBERG

Lantime configuration utility 1.27

Lantime:	ELX800/MSF M3x V5.28f	Host:	LantimeV5
S/N:	030110090170	Domain:	py.meinberg.de
Contact:	Meinberg	IPv4:	172.16.3.143
Location:	Germany	IPv6:	3ffe:302:11:2:213:95ff:fe00:7f9c/64 (IP by RA)

MSF Status:	NORMAL OPERATION	Uptime:	3 days, 2:34
NTP Status:	Offs. PPS:-25us		
Receiver information:	sync; Field: 88;		

Last messages:

```

2009-08-06 09:53:01 UTC: lantime -> Refclock sync
2009-08-06 09:51:01 UTC: lantime -> Refclock not synchronized
2009-08-04 22:58:04 UTC: lantime -> Refclock sync
2009-08-04 22:53:03 UTC: lantime -> Refclock not synchronized
2009-08-04 22:47:06 UTC: lantime -> Refclock sync
2009-08-04 22:44:05 UTC: lantime -> Refclock not synchronized

```

Configuration & Management:

[Ethernet](#)
[Notification](#)
[Security](#)
[NTP](#)
[Local](#)
[Statistics](#)
[Manual](#)
[Logout](#)

The start page gives a short overview of the most important configuration parameters and the runtime statistics of the unit. In the upper left corner you can read which LANTIME model and which version of the LANTIME software you are using. This LANTIME software version is a head version number describing the base system and important subsystems. Below the version you will find the actual hostname and domain of your LANTIME unit, the IPv4 and IPv6 network address of the first network interface and on the right side the serial number, the uptime of the system (time since last boot) and the notification status.

In the second section the actual status of the GPS reference clock and the NTP subsystem is shown, additional information about the GPS receiver are also found here. This includes the number of satellites in view and the number of good satellites in view.

The third section shows the last messages of the system, with a timestamp added. The newest messages are on top of the list. This is the content of the file `/var/log/messages`, which is created after every start of the system (and is lost after a power off or reboot).

By using the buttons in the lower part of the screen, you can reach a number of configuration pages, which are described below.

11.2 Configuration: Ethernet

Ethernet configuration

Main network information:

Hostname:

Domainname:

Nameserver 1:

Nameserver 2:

Syslogserver 1:

Syslogserver 2:

Default Gateways:

IPv4 Gateway:

IPv6 Gateway:

Available network services:

	Telnet	FTP	SSH	HTTP	HTTPS	SNMP	NETBIOS	TIME
Active:	<input checked="" type="checkbox"/>	<input checked="" type="checkbox"/>	<input checked="" type="checkbox"/>	<input checked="" type="checkbox"/>	<input checked="" type="checkbox"/>	<input type="checkbox"/>	<input type="checkbox"/>	<input checked="" type="checkbox"/>

Available internet protocols:

	IPv4	IPv6
Active:	<input checked="" type="checkbox"/>	<input checked="" type="checkbox"/>

Available network interfaces: 2

Interface 0:

TCP/IP address:

Netmask:

DHCP-Client:

Net link mode:

High availability bonding:

IP from DHCP:

Gateway from DHCP:

Netmask from DHCP:

Indicate Link on Front Panel LED:

IPv6 1:

IPv6 2:

IPv6 3:

Autoconf:

IP by Router Advertisement:

Link local:

Additional network configuration:

In the network configuration all parameters related to the network interfaces can be changed. In the first section you can change the hostname and domain name. You can also specify two nameserver and two SYSLOG server. In the nameserver and syslog server fields you may enter an IPv4 or IPv6 address (the syslog servers can be specified as a hostname, too).

11.2.1 SYSLOG Server

All information written to the LANTIME SYSLOG (/var/log/messages) can be forwarded to one or two remote SYSLOG servers. The SYSLOG daemon of this remote SYSLOG needs to be configured to allow remote systems to create entries. A Linux SYSLOGD can be told to do so by using the command "syslogd -r" when starting the daemon.

If you enter nothing in the SYSLOG server fields or specify 0.0.0.0 as the SYSLOG servers addresses, the remote SYSLOG service is not used on your LANTIME.

Please be aware of the fact that all SYSLOG entries of the timeserver are stored in /var/log/messages and will be deleted when you power off or reboot the timeserver. A daily CRON job is checking for the size of the LANTIME SYSLOG and deletes it automatically, if the log size is exceeding a certain limit.

By specifying one or two remote SYSLOG servers, you can preserve the SYSLOG information even when you need to reboot or switch off the LANTIME.

In the second section the possible network protocols and access methods can be configured. You can enable/disable TELNET, FTP, SSH, HTTP, HTTPS, SNMP and NETBIOS by checking/unchecking the appropriate check boxes. After you saved your settings with the "Save" button, all these subsystems are stopped and eventually restarted (only if they are enabled, of course).

The third section allows you to select the IP protocol version 6. In this version the IPv4 protocol is mandatory and cannot be disabled, but as a workaround a standalone IPv6 mode can be achieved by entering an IPv4 address "0.0.0.0" and disabling the DHCP client option for every network interface of your LANTIME. By doing so, you ensure that the timeserver cannot be reached with IPv4. Please note that TELNET, FTP and NETBIOS cannot be used over IPv6 in this version. It is no problem to use IPv4 and IPv6 in a mixed mode environment on your LANTIME.

11.3 Network interface specific configuration

The interface specific parameters can be found in the Interface section. If your LANTIME is equipped with only one network interface, you will find only one sub section (Interface 0). Otherwise you see a sub section for each installed Ethernet port.

Here, the parameters for the network port can be changed. In the upper section of the page you can enter the IPv4 parameters, the lower part gives you access to the IPv6 parameters of the interface.

11.3.1 IPv4 addresses and DHCP

IPv4 addresses are built of 32 bits, which are grouped in four octets, each containing 8 bits. You can specify an IP address in this mask by entering four decimal numbers, separated by a point “.”.

Example: 192.168.10.2

Additionally you can specify the IPv4 netmask and your default gateway address. Please contact your network administrator, who can provide you with the settings suitable for your specific network.

If there is a DHCP (Dynamic Host Configuration Protocol) server available in your network, the LANTIME system can obtain its IPv4 settings automatically from this server. If you want to use this feature (again, you should ask your network administrator whether this is applicable in your network), you can change the DHCP Client parameter to “ENABLED”. In order to activate the DHCP client functionality, you can also enter the IP address “000.000.000.000” in the LCD menu by using the front panel buttons of the LANTIME. Using DHCP is the default factory setting.

The MAC address of your timeserver can be read in the LCD menu by pressing the NEXT button on the front panel twice. This value is often needed by the network administrator when setting up the DHCP parameters for your LANTIME at the DHCP server.

If the DHCP client has been activated, the automatically obtained parameters are shown in the appropriate fields (IPv4 address, netmask, gateway).

11.3.2 IPv6 addresses and autoconf

You can specify up to three IPv6 addresses for your LANTIME timeserver. Additionally you can switch off the IPv6 autoconf feature. IPv6 addresses are 128 bits in length and written as a chain of 16bit numbers in hexadecimal notation, separated with colons. A sequence of zeros can be substituted with “::” once.

Examples:

“::” is the address, which simply consists of zeros
“::1” is the address, which only consists of zeros and a 1 as the last bit. This is the so-called host local address of IPv6 and is the equivalent to 127.0.0.1 in the IPv4 world

“fe80::0211:22FF:FE33:4455” is a typical so-called link local address, because it uses the “fe80” prefix.

In URLs the colon interferes with the port section, therefore IPv6-IP-addresses are written in brackets in an URL.
 (“http://[1080::8:800:200C:417A]:80/” ;
the last “:80” simply sets the port to 80, the default http port)

If you enabled the IPv6 protocol, the LANTIME always gets a link local address in the format “fe80:: ...”, which is based upon the MAC address of the interface. If a IPv6 router advertiser is available in your network and if you enabled the IPv6 autoconf feature, your LANTIME will be set up with up to three link global addresses automatically.

The last parameter in this sub section is "Netlink mode". This controls the port speed and duplex mode of the selected Ethernet port. Under normal circumstances, you should leave the default setting ("autosensing") untouched, until your network administrator tells you to change it.

11.3.3 High Availability Bonding

The standard moniker for this technology is IEEE 802.3ad, although it is known by the common names of trunking, port trunking, teaming and link aggregation. The conventional use of bonding under Linux is an implementation of this link aggregation.

Only one link is used at any given time. At least two physical Ethernet ports must be linked to one bonding group to activate this feature. The first Ethernet Port in one bonding group provides the IP-Address and the net mask of this new virtual device. The implementation of the LANTIME Bonding feature will not replace the MAC address of the active ethernet port. Depending on the LINK state of the ETH-port the IP address of the first port in the bonding group will be set to the next ethernet port. All services will be restarted automatically.

11.3.4 Additional Network Configuration

You can configure additional network parameter like special network routes or alias definitions. For this you will edit a script file which will be activated every time after the network configuration will run.

Ethernet configuration

Content of /mnt/flash/config/netconf.cmd:

```
#!/bin/bash
#Example how to setup an additional route
#route add -net 172.16.6.0 netmask 255.255.255.0 eth0
```

Save file Close

Also the Samba Configuration from “/etc/samba/smb.conf” can be edited:

Ethernet configuration

Content of /mnt/flash/config/samba/smb.cnf:

```
# smb.conf is the main samba configuration file.
[global]
    workgroup = MEINBERG
    map to guest = Bad User
    os level = 2
    time server = Yes
    unix extensions = Yes
    encrypt passwords = Yes
    log level = 1
    syslog = 0
    printing = CUPS
```

Save file Close

11.4 Configuration: Notification

Notification management

Email information:

To address:

From address:

Smarthost:

Windows messenger information (WinPopup):

Mail address 1:

Mail address 2:

SNMP information:

SNMP manager 1: <input type="text"/>	Community: <input type="text"/>
SNMP manager 2: <input type="text"/>	Community: <input type="text"/>
SNMP manager 3: <input type="text"/>	Community: <input type="text"/>
SNMP manager 4: <input type="text"/>	Community: <input type="text"/>

VP100/NET display information:

Display 1: <input type="text"/>	Serial number: <input type="text"/>
Display 2: <input type="text"/>	Serial number: <input type="text"/>

User defined notification:

NTP client monitoring:

NTP client offset limit: ms

NTP client stratum limit:

Notification conditions:

Condition:	Triggers:					
	Email	Wmail	SNMP	VP100/NET	User	Relais
Normal Operation	<input type="checkbox"/>	<input type="checkbox"/>	<input type="checkbox"/>	<input type="checkbox"/>	<input type="checkbox"/>	<input checked="" type="checkbox"/>
NTP not sync	<input type="checkbox"/>	<input type="checkbox"/>	<input type="checkbox"/>	<input type="checkbox"/>	<input type="checkbox"/>	<input type="checkbox"/>
NTP stopped	<input type="checkbox"/>	<input type="checkbox"/>	<input type="checkbox"/>	<input type="checkbox"/>	<input type="checkbox"/>	<input type="checkbox"/>
Server boot	<input type="checkbox"/>	<input type="checkbox"/>	<input type="checkbox"/>	<input type="checkbox"/>	<input type="checkbox"/>	<input type="checkbox"/>
Receiver not responding	<input type="checkbox"/>	<input type="checkbox"/>	<input type="checkbox"/>	<input type="checkbox"/>	<input type="checkbox"/>	<input type="checkbox"/>
Receiver not sync	<input type="checkbox"/>	<input type="checkbox"/>	<input type="checkbox"/>	<input type="checkbox"/>	<input type="checkbox"/>	<input type="checkbox"/>
Receiver sync	<input type="checkbox"/>	<input type="checkbox"/>	<input type="checkbox"/>	<input type="checkbox"/>	<input type="checkbox"/>	<input type="checkbox"/>
Config changed	<input type="checkbox"/>	<input type="checkbox"/>	<input type="checkbox"/>	<input type="checkbox"/>	<input type="checkbox"/>	<input type="checkbox"/>
NTP client offset limit	<input type="checkbox"/>	<input type="checkbox"/>	<input type="checkbox"/>	<input type="checkbox"/>	<input type="checkbox"/>	<input type="checkbox"/>

11.4.1 Alarm Events

On this page you can set up different notification types for a number of events. This is an important feature because of the nature of a timeserver: running unobserved in the background. If an error or problem occurs, the timeserver is able to notify an administrator by using a number of different notification types.

The LANTIME timeserver offers different ways of informing the administrator or a responsible person about nine different events: EMAIL sends an e-mail message to a specified e-mail account, SNMP-TRAP sends a SNMP trap to one or two SNMP trap receivers, WINDOWS POPUP MESSAGE sends a winpopup message to one or two different computers. DISPLAY shows the alarm message on a wall mount display model VP100/NET, which is an optional accessory you can obtain for your LANTIME. You also can use user defined scripts and the error relay out (see appendix).

Attention: mbgLtTrapNormalOperation clears everything! It is a master trap to show that the LANTIME is running in full state!



Trapname	Cleared By
NTPStopped	NTPNotSync or NTP Sync
NTPNotSync	NTPSync
ReceiverNotResponding	ReceiverNotSync or ReceiverSync
ReceiverNotSync	ReceiverSync
AntennaFaulty	AntennaReconnect
SecondaryRecNotSync	SecondaryRecSync
PowerSupplyFailure	PowerSupplyUp
NetworkDown	NetworkUp
SecondaryRecNotResp	RecNotSync or RecSync

The following traps are notifications that do not have a "clearing" trap:

- mbgLtTrapConfigChanged
- mbgLtTrapLeapSecondAnnounced
- mbgLtTrapServerBoot

Every event can use a combination of those four notification types, of course you can disable notification for an event (by just disabling all notification types for this event). The configuration of the four notification types can be changed in the upper section of the page, you can control which notification is used for which event in the lower part of the page.

11.4.2 E-mail messages

You can specify the e-mail address which is used as the senders address of the notification e-mail (From: address), the e-mail address of the receiver (To: address) and a SMTP smarthost, that is a mail server forwarding your mail to the receiver's mail server. If your LANTIME system is connected to the internet, it can deliver those e-mails itself by directly connecting to the receivers mail server. Additional e-mail addresses can be specified via the CC-recipients button.

These settings cannot be altered with the LC display buttons of the front panel. Please note the following:

- The host name and domain name should be known to the SMTP smarthost
- A valid nameserver entry is needed
- The domain part of the "From:" address has to be valid

11.4.3 Windows Popup Messages

Most Microsoft Windows operating systems provide you with a local notification tool. You can send messages via the special Windows protocol in your local network. It is not necessary to enable the NETBIOS protocol of the LANTIME in order to use this notification. On the Windows client side it is necessary to activate the "Microsoft Client for Windows" in the network configuration.

You can enter the Windows computer name of up to two Windows PCs in the appropriate fields. Every message contains a time stamp and a plain text message:

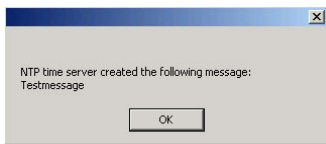

11.4.4 SNMP-TRAP messages

Up to two SNMP trap receiver hosts can be configured in this subsection, you may use IPv4 or IPv6 addresses or specify a hostname. Additionally you have to enter a valid SNMP community string for your trap receiving community. These can be unrelated to the SNMP community strings used for status monitoring and configuration access (see SNMP configuration on the "Security" page).

11.4.5 VP100/NET wall mount display

The VP100/NET wall display is an optional accessory for the LANTIME timeserver, it has an own integrated Ethernet port (10/100 Mbit) and a SNTP client. The time for the display can be received from any NTP server using the SNTP protocol (like your LANTIME), additionally the display is capable of showing text messages, which are sent by using a special utility. The LANTIME can send an alarm message to one or two VP100/NET displays over the network, whenever an event occurs for which you selected the display notification type. If this happens, a scrolling alarm message is shown three times on the display.

Just enter the display's IP address and its serial number (this is used for authorisation), which can be found by pressing the SET button on the back of the display four times. The serial number consists of 8 characters, representing four bytes in hexadecimal notation.

If you want to use the display for other purposes, you can send text messages to it by using our command line tool send2display, which can be found on the LANTIME. This allows you to use the display by CRON jobs or your own shell scripts etc. If you run the tool without parameters, a short usage screen is shown, explaining all parameters it may understand. See appendix for a printout of this usage screen.

11.4.6 User defined Alarm scripts

You can define your own alarm script for every event by using the "Edit user defined notification script". This script will be called automatically if one of the selected events occurs.

This user alarm script will be stored on the Flash-Disk at “/mnt/flash/user_defined_notification”. This script will be called with index and the alarm message as text. The index value of the test message is 0.

11.4.7 NTP Client Monitoring

You can monitor a group of NTP clients and supervise the time offset, the NTP stratum value and if the client is reachable or not. With the button „edit client list“ you can edit the list of clients to monitor. You can add the TCP/IP address or the hostname of the client:

Notification management

Please insert up to 100 client address to monitor in a separate line

Content of /mnt/flash/config/clients_to_manage:

Save file
Close

You can monitor the current states of the configured clients:

11.4.8 Alarm messages

You can change the alarm message text for every event by using the "Edit Messages" button, the messages are stored in a file /mnt/flash/notification_messages on the flash disk of your timeserver.

Notification management

Notification conditions: please adjust the messages to fulfill your needs

Condition:	Adjusted condition:
Normal Operation	
NTP not sync	
NTP stopped	
Server boot	
Receiver not responding	
Receiver not sync	
Receiver sync	
Config changed	
NTP client offset limit	
Default messages	

Save settings
Reset changes
Back

11.5 Configuration: Security

Security management

Login:

Front Panel:

Lock Front Panel:

SSH key generation:

HTTPS certificate generation:

NTP autokey generation:

NTP autokey password:

NTP symmetric keys:

SNMP:

Read community String:

Read/Write community string:

SNMP contact:

SNMP location:
[Please edit these values on the local page](#)

User name:

Authentication passphrase:

Re-enter passphrase:

11.5.1 Password

On the “Security” page you can manage all security relevant parameters for your timeserver. In the first section “Login” the administration password can be changed, which is used for SSH, TELNET, FTP, HTTP and HTTPS access. The password is stored encrypted on the internal flash disk and can only be reset to the default value “timeserver” by a “factory reset”, changing all settings back to the factory defaults. Please refer to the LCD configuration section in this manual.

11.5.2 HTTP Access Control

The screenshot shows a web interface titled "Security management". Under the "HTTP access control:" section, there is an empty text input field and a button labeled "Add/Remove address". Below this, the "Authorised TCP/IP addresses:" section contains a large grey box with the text "no access control currently configured". A "Close" button is located at the bottom right of the interface.

With this function you can restrict the access to the web interface and allow only a few hosts to login. Only the hosts you entered in the list are able to login to the HTTP/HTTPS server of your LANTIME.

If a non-allowed host tries to login, the following message appears:

The screenshot shows a web interface titled "GPS controlled NTP time server". At the top, a red message reads "Access denied - no authorization for log in from 172.16.3.20". Below this, a table displays system information:

GPS:	NORMAL OPERATION	Time:	UTC 10:00:52
NTP:	Offs. PPS: 2us	Date:	Fri, 21.08.2009
Host:	LantimeV5	IP:	172.16.3.153
Contact:	Meinberg	Location:	Germany

To the right of the table is an image of a globe with a clock and a GPS receiver. Below the table is a login form titled "Login for configuration and statistic" with fields for "User:" (containing "root") and "Password:" (masked with dots), and a "login" button.

11.5.3 SSH Secure Shell Login

The SSH provides you with a secure shell access to your timeserver. The connection is encrypted, so no readable passwords are transmitted over your network. The actual LANTIME version supports SSH1 and SSH2 over IPv4 and IPv6. In order to use this feature, you have to enable the SSHD subsystem and a security key has to be generated on the timeserver by using the “Generate SSH key” button. Afterwards, a SSH client can connect to the timeserver and opens a secure shell:

ssh root @ 192.168.16.111

The first time you connect to a SSH server with an unknown certificate, you have to accept the certificate, afterwards you are prompted for your password (which is configured in the first section of this page).

Default Password: **timeserver**

If you generate a new SSH key, you can copy and paste it into your SSH client configuration afterwards in

order to allow you to login without being prompted for a password. We strongly recommend to use SSH for shell access, TELNET is a very insecure protocol (transmitting passwords in plain text over your network).

If you enabled SSH, your LANTIME automatically is able to use secure file transfer with SCP or SFTP protocol. The usage of FTP as a file transfer protocol is as insecure as using TELNET for shell access.

Security management

Content of /tmp/ssh_key_output:

```
SSH V1 Host Key:
2048 35
204679788021329252372503609562528762286113530350421434149820788854442325389250575506090209169422266
root@LantimeV5
-----
SSH V2 Host RSA Key:
ssh-rsa
AAAAB3NzaC1yc2EAAAABIwAAAQEAzcxUTSvEQeWQ8qaGJLujZE6+eDvzIV4cqruFTClJKexia3W6komT6gKt3kbG4yNf0Ni8R117
```

Close

11.5.4 Generate SSL Certificate for HTTPS

HTTPS is the standard for encrypted transmission of data between web browser and web server. It relies on X.509 certificates and asymmetric crypto procedures. The timeserver uses these certificates to authenticate itself to the client (web browser). The first time a web browser connects to the HTTPS web server of your LANTIME, you are asked to accept the certificate of the web server. To make sure that you are talking to your known timeserver, check the certificate and accept it, if it matches the one stored on the LANTIME. All further connections are comparing the certificate with this one, which is saved in your web browser configuration. Afterwards you are prompted to verify the certificate only when it changed.

By using the button "Generate SSL certificate for HTTP" you can create a new certificate. Please enter your organisation, name, mail address and the location in the upcoming form and press "Generate SSL certificate" to finally generate it.

Generate HTTPS certificate

Please fill out the following fields:

Country Name(*): (2 letter code)

Locality Name(*):

Organization Name(*):

Organizational Unit:

Common Name(*):

Email Address(*):

Generate Diffie-Hellman parameter

Fields marked with * are mandatory

After the successful generation of the certificate, it is shown to you:

Security management

Content of /www/filetmp:

```

-----BEGIN RSA PRIVATE KEY-----
MIICWwIBAAKAgQCM2KDSx8SDvYv94HyISK2bcS1d3hEAf2heGPheTCqe8HgQRh
dvd3qEJlvyESeaxk47a09EaEksrxRhROIRnqHvRUu2Iw1ZuW0Qb1VohrLH+Vyd
jWzE0+zVQzSLZa117G6B8ZuPBog31XwMfaDMu+5WbZNPcRHy/Je+VbbswIDAQAB
AcSARFwfd420eBPaDwzFmzx4gSNNj+3eBisZWFU/Se169z1V1SROT00XObw96
DC2ndFCc4M1aB+A0js1P4DIHr9pR27w1z10zctXNEJNqaelMrCh/66a5YBY3/
OKCbdVGLSCGUzNqF/foavAB81IwYJDIreChYXjYp9kCQDtcck2kqLSZ1Ly
kgRzct4g1nA4g95klyFXKQDgQq34h/epJOEoMnpICXYYSvMcWnNp/Sh18TDkwf
epYQRhVAKeAyzrc0nuPSJUtbwS063091g9IC/mZh44rdJ0JscRu33wGZeuZndM
G5YbK43FAd3d46qBwYfSm35ULFv072wDAEapHvriS36c0jKqKamDrT79CCG
Mxc3PKbX11FaNnyGL1ZP187nR25uBuKcCNpupMZAqgiI+X1JPaXzSN3QJAZkC6

```

It is also possible to upload your own HTTPS certification. If you upload a non valid certification HTTPS will not work.

11.5.5 NTP keys and certificates

The fourth and fifth section of the “Security” page allow you to create the needed crypto keys and certificates for secure NTP operation (please see NTP authentication below).

The function “Generate new NTP public key” is creating a new self-signed certificate for the timeserver, which is automatically marked as “trusted”.

Important note: This certificate is depending on the hostname of your LANTIME, it is mandatory to re-create the certificate after changing the hostname. The certificates are build with the internal command “ntp-keygen -T” (ntp-keygen is part of the installed NTP suite). Your LANTIME is using the /etc/ntp/ directory for storing its private and public keys (this is called the “keysdir”). Please refer to the chapter “NTP Autokey” for further information (below).

The two options “Show NTP MD5 key” and “Edit NTP MD5 keys” allow you to manage the symmetric keys used by NTP. More about that can be found in the chapter about symmetric keys (below).



11.5.6 SNMP Parameter

In the last Section all parameters for SNMP can be configured. More information you can find later in this manual.

11.6 Configuration: NTP

NTP management

NTP configuration:

External NTP server address 1:	<input type="text"/>	Key:	<input type="text"/>	<input type="checkbox"/> use autokey
External NTP server address 2:	<input type="text"/>	Key:	<input type="text"/>	<input type="checkbox"/> use autokey
External NTP server address 3:	<input type="text"/>	Key:	<input type="text"/>	<input type="checkbox"/> use autokey
External NTP server address 4:	<input type="text"/>	Key:	<input type="text"/>	<input type="checkbox"/> use autokey
External NTP server address 5:	<input type="text"/>	Key:	<input type="text"/>	<input type="checkbox"/> use autokey
External NTP server address 6:	<input type="text"/>	Key:	<input type="text"/>	<input type="checkbox"/> use autokey
External NTP server address 7:	<input type="text"/>	Key:	<input type="text"/>	<input type="checkbox"/> use autokey

Stratum of local clock:

disable local clock

Local trusted key:

NTP broadcast address: Key: use autokey

Broadcast interval: seconds

NTP trusttime: Days
0=Standard receiver trust time used (4 days)

Active:	Autokey	PPS
<input type="checkbox"/>	<input type="checkbox"/>	<input checked="" type="checkbox"/>

Edit additional NTP parameter
Show current NTP configuration

Config NTP access control

Save settings
Reset changes
Back

The NTP configuration page is used to set up the additional NTP parameters needed for a more specific configuration of the NTP subsystem.

The default configuration of the timeserver consists of a local clock, which represents the hardware clock of your LANTIME system and the GPS reference clock. The local clock is only chosen as the NTP time reference after the GPS clock lost its synchronisation. The stratum level of this local clock is set to 12, this ensures that clients recognise the switchover to the local clock and are able to eventually take further actions. The local clock can be disabled if the timeserver should not answer any more when the reference clock is out of order.

Because the reference clock is internally connected to the LANTIME system by using a serial connection, the accuracy using this way of synchronisation is around 1 ms. The high accuracy of the LANTIME timeserver (around 10 microseconds) is available by using the ATOM driver of the NTP subsystem, which is directly interpreting the PPS (pulse per second) of the GPS reference clock. The default configuration looks like this:

```
# *** lantime ***
# NTP.CONF for GPS167 with UNI ERLANGEN

server 127.127.1.0           # local clock
fudge 127.127.1.0 stratum 12 # local stratum

server 127.127.8.0 mode 135 prefer # GPS167 UNI Erlangen PPS
fudge 127.127.8.0 time1 0.0042    # relative to PPS
server 127.127.22.0          # ATOM (PPS)
fudge 127.127.22.0 flag3 1      # enable PPS API
enable stats
```

```

statsdir /var/log/
statistics loopstats
driftfile /etc/ntp.drift

# Edit /mnt/flash/ntpconf.add to add additional NTP parameters

```

By using the NTP configuration page, a number of additional parameters can be added to this default ntp.conf. In the upper section up to five external NTP servers can be set up to provide a high grade of redundancy for the internal reference clock. For each of these external NTP servers the AUTOKEY or symmetric key feature of NTP can be used to ensure the authentic of these time sources. The “Prefer” flag can be set for each external server. The internal refclock has set this flag by default. The “Prefer” flag is usefull if one of the refclocks are not available or out of sync.

The field “Stratum of local clock” is used to change the stratum level of the local clock (see above), default is 12.

The “Local trusted key” field holds a list of all trusted symmetric keys (comma or space separated), which have to be accepted by the NTPD of your LANTIME.

If you want to use your LANTIME timeserver to send NTP broadcast packets to your network, you have to enter a valid broadcast address in “NTP broadcast address”. If you want to use IPv6 multicast mode, you have to enter a valid IPv6 multicast address in this field. Please note that NTP Version 4, which is used by the LANTIME timeserver, only permits authenticated broadcast mode. Therefore you have to set up the AUTOKEY feature or a symmetric key if you use a NTPv4 client and want to broadcast / multicast your time. A sample configuration of the NTP client for broadcast with symmetric keys looks like:

```

broadcastclient yes
broadcastdelay 0.05    # depends on your network
keys /etc/ntp/keys
trustedkey 6 15
requestkey 15
controlkey 15

```

In the next section you can enable the AUTOKEY feature for your LANTIME timeserver and the PPS mode (which is enabled in default settings), see above for a description.

The NTP Trusttime will specify the time how long the NTP will trust the reference time if this is not synchronized (free running). This time will be set in seconds or minutes or hours. The value 0 will be select the default value for the specific reference clock. The default values are:

```

LANTIME/GPS:      96 h
LANTIME/PZF:      0,5 h
LANTIME/RDT:      0,5 h
LANTIME/NDT:      96 h

```

After each restart and after any change of configuration a new /etc/ntp.conf file is generated by the LANTIME software. Any changes you made to this file are lost. In order to use your custom ntp.conf (your LANTIME is using a standard version of the NTP software suite, therefore all configuration parameters of the NTP software are fully supported), you have to edit the file /mnt/flash/ntpconf.add, which is automatically appended to the /etc/ntp.conf file generated at boot time or when reloading configuration after a change. You can edit this file by using the button “Edit additional NTP parameter”.



By choosing “Show current NTP configuration”, you can review the actual state of the `/etc/ntp.conf` file. The file cannot be changed on this page, see above for a description why editing this file is not reasonable.

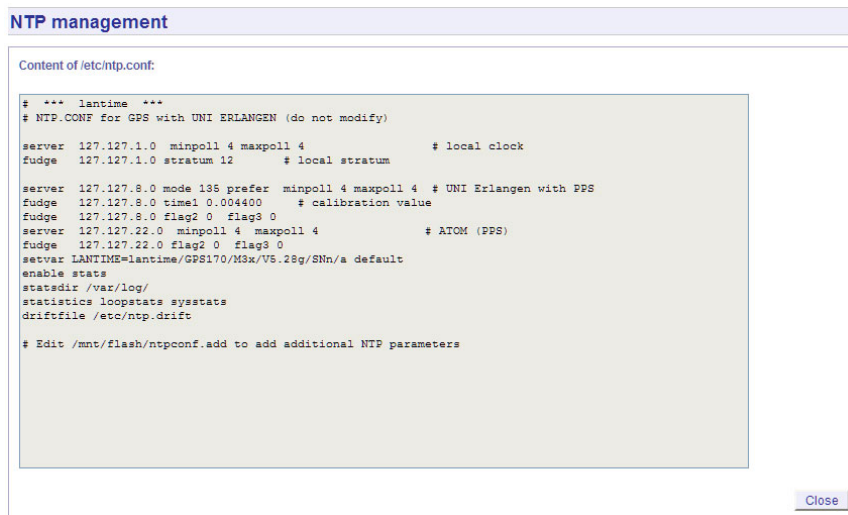

11.6.1 NTP Authentication

NTP version 2 and version 3 support an authentication method using symmetric keys. If a packet is sent by the NTPD while using this authentication mode, every packet is provided with a 32 bit key ID and a cryptographic 64/128 bit checksum of the packet. This checksum is built with MD5 or DES, both algorithms offer a sufficient protection against manipulation of data.

Please note that the distribution of DES in the United States of America and Canada is subject to restrictions, while MD5 is not affected by that. With any of these algorithms the receiving NTP clients validate the checksum. Both parties (server and client) need to have the same crypto key with the same key ID.

In the authentication mode a party is marked “untrusted” and not suitable for synchronisation, whenever unauthorised packets or authorised packets with a wrong key are used. Please note that a server may recognise a lot of keys but uses only a few of them. This allows a timeserver to serve a client, who is demanding an authenticated time information, without “trusting” the client.

Some additional parameters are used to specify the key IDs used for validating the authentic of each partner. The configuration file `/etc/ntp.conf` of a server using this authentication mode may look like this:

```
# peer configuration for 128.100.100.7
# (expected to operate at stratum 2)
# fully authenticated this time

peer 128.100.49.105 key 22 # suzuki.ccie.utoronto.ca
peer 128.8.10.1 key 4 # umd1.umd.edu
peer 192.35.82.50 key 6 # lilben.tn.cornell.edu

keys /mnt/flash/ntp.keys # path for key file
trustedkey 1 2 14 15 # define trusted keys
requestkey 15 # key (mode 6) for accessing server variables
```

```
controlkey 15          # key (mode 7) for accessing server variables
```

The “keys” parameter indicates the location of the file, in which all symmetric keys are stored. The “trustedkey” line identifies all key IDs, which have to be considered “trusted” or “uncompromised”. All other keys defined in the keyfile are considered “compromised”. This allows to re-use already owned keys by just adding their respective key ID to the “trustedkey” parameter. If a key needs to be “switched off”, it can be removed from this line without actually removing it from the system. This ensures an easy way to re-activate it later without actually transferring the key again.

The line “requestkey 15” declares the key ID for mode-6 control messages (as described in RFC-1305), which are used by the ntpq utility for example. The “controlkey” parameter is specifying the key used for mode-7 private control messages, for example used by the ntpdc utility. These keys protect the ntpd variables against unauthorised modification.

The ntp.keys file mentioned above holds a list of all keys and their respective ID known by the server. This file should not be world-readable (only root should be able to look into this) and it may look like this:

```
# ntp keys file (ntp.keys)
```

```
1      N 29233E0461ECD6AE    # des key in NTP format
2      M RIrop8KPPvQvYotM    # md5 key as an ASCII random string
14     M sundial              # md5 key as an ASCII string
15     A sundial              # des key as an ASCII string
                                # the following 3 keys are identical
10     A SeCReT
10     N d3e54352e5548080
10     S a7cb86a4cba80101
```

The first column holds the key ID (used in the ntp.conf file), the second column defines the format of the key, which is following in column three. There are four different key formats:

- “**A**” means DES key with up to eight 7-bit ASCII characters, where each character is standing for a key octet (this is used by Unix passwords, too).
- “**S**” is a DES key written in hexadecimal notation, where the lowest bit (LSB) of each octet is used as the odd parity bit.
- If the key format is specified as “**N**”, it also consists of a hexadecimal string, but in NTP standard format by using the highest bit (HSB) of each octet used as the odd parity bit.
- A key defined as “**M**” is a MD5 key with up to 31 ASCII characters.
- The LANTIME supports MD5 authentication only.
- Please be aware of the following restrictions: No “**#**”, “**t** (tab)”, “**n** (newline)” and “**0** (null)” are allowed in a DES or MD5 ASCII key. The key ID 0 is reserved for special purposes and should not appear in the keys file.

11.6.2 NTP AUTOKEY

NTP Version 4 supports symmetric keys and additionally provides the so-called AUTOKEY feature. The authentic of received time at the NTP clients is sufficiently ensured by the symmetric key technique. In order to achieve a higher security, e.g. against so-called replay attacks, it is important to change the used crypto keys from time to time.

In networks with a lot of clients, this can lead to a logistic problem, because the server key has to be changed on every single client. To help the administrator to reduce this work (or even eliminate it completely), the NTP developers invented the AUTOKEY feature, which works with a combination of group keys and public keys. All NTP clients are able to verify the authentic of the time they received from the NTP servers of their own AUTOKEY group by using this AUTOKEY technique.

The AUTOKEY features works by creating so-called secure groups, in which NTP servers and clients are combined. There are three different kinds of members in such a group:

a) Trusted Host

One or more trusted NTP servers. In order to become a “trusted” server, a NTP server must own a self-signed certificate marked as “trusted”. It is good practice to operate the trusted hosts of a secure group at the lowest stratum level (of this group).

b) Host

One or more NTP servers, which do not own a “trusted” certificate, but only a self-signed certificate without this “trusted” mark.

c) Client

One or more NTP client systems, which in contrast to the above mentioned servers do not provide accurate time to other systems in the secure group. They only receive time.

All members of this group (trusted hosts, hosts and clients) have to have the same group key. This group key is generated by a so-called trusted authority (TA) and has to be deployed manually to all members of the group by secure means (e.g. with the UNIX SCP command). The role of a TA can be fulfilled by one of the trusted hosts of the group, but an external TA can be used, too.

The used public keys can be periodically re-created (there are menu functions for this available in the web interface and also in the CLI setup program, see “Generate new NTP public key” in section “NTP Autokey” of the “Security Management” page) and then distributed automatically to all members of the secure group. The group key remains unchanged, therefore the manual update process for crypto keys for the secure group is eliminated. A LANTIME can be a trusted authority / trusted host combination and also a “non-trusted” host in such a secure group.

To configure the LANTIME as a TA / trusted host, enable the AUTOKEY feature and initialise the group key via the HTTPS web interface (“Generate groupkey”) or CLI setup program. In order to create such a group key, a crypto password has to be used in order to encrypt / decrypt the certificate. This crypto password is shared between all group members and can be entered in the web interface and CLI setup program, too. After generating the group key, you have to distribute it to all members of your secure group (and setup these systems to use AUTOKEY, too). In the ntp.conf file of all group members you have to add the following lines (or change them, if they are already included):

```
crypto pw cryptosecret
keysdir /etc/ntp/
```

In the above example “cryptosecret” is the crypto password, that has been used to create the group key and the public key. Please note that the crypto password is included as a plain text password in the ntp.conf, therefore this file should not be world-readable (only root should have read access to it).

On the clients, the server entries must be altered to enable the AUTOKEY feature for the connections to the NTP servers of the group. This looks like:

```
server time.meinberg.de autokey version 4
server time2.meinberg.de
```

You find the server time.meinberg.de which is using the AUTOKEY feature, while time2.meinberg.de is used without any authentic checks.

If you want to setup the LANTIME server as a trusted host, but need to use a different trusted authority, please create your own group key with this TA and include it with the web interface of your LANTIME (on page “Security Management” see section “NTP autokey”, function “Upload groupkey”).

If you want to setup the LANTIME as a “non-trusted” NTP server, you have to upload the group key of your secure group (“Security Management” / “NTP autokey” / “Upload groupkey”) and create your own, self-signed certificate (without marking it as “trusted”). Because every certificate which is creating by using the web interface and/or CLI setup is marked “trusted”, you have to execute the tool “ntp-keygen” manually on your LANTIME by

using shell access (via SSH).

```
LantimeGpsV4:/etc/ntp # ntp-keygen -q cryptosecret
```

Here, too, “cryptosecret“ is the crypto password used in the ntp.conf entry. Then you have to copy the new ntpkeys to the flash disk with:

```
cp /etc/ntp/ntpkey_* /mnt/flash/config/ntp/uploaded_groupkeys
```

A detailed description about ntp-keygen can be found on the NTP website (<http://www.ntp.org>).

Example:

This autokey group is formed by one Stratum-1-server (B), two Stratum-2-servers (D and E) and a number of clients (in the diagram there are 4 clients shown, c1 – c4). B is the trusted host, he holds the group key and a self-signed certificate marked as “trusted”.

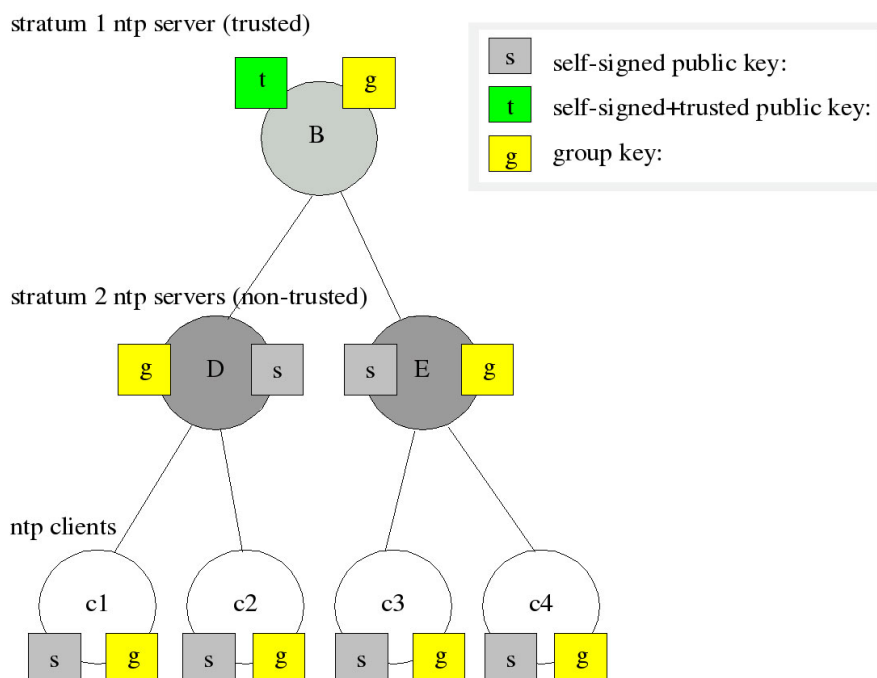

D and E are NTP servers, which are “non-trusted” hosts of the group, they hold the group key and a self-signed certificate which lacks the “trusted” mark. The clients also hold the group key and a self-signed certificate. In order to distribute new public keys to the whole group, the administrator only has to generate a new “t” key, which will be distributed automatically to the two hosts D and E. Because these two servers can now present a unbroken chain of certificates to a trusted host, they can be considered “trusted” by the clients as well.

More about the technical background and detailed processes of the AUTOKEY technique can be found at the official NTP website (<http://www.ntp.org>).

11.7 Configuration: Local

Local configuration

Lantime services:

[Reboot device](#)

[Manual configuration](#)

[Send test notification](#)

[Save NTP drift file](#)

[Reset to factory defaults](#)

[Download SNMP MIB files](#)

[Reset Error Relais](#)

Lantime User Management:

[User administration](#)

Show Lantime information:

[List all messages](#)

[List detailed version information](#)

[List device options](#)

Lantime firmware update:

[Durchsuchen...](#)

[Start firmware update](#)

[View logfile of last update](#)

Lantime configuration:

[Check configuration](#)

[Get diagnostics information](#)

Receiver:

[List detailed GPS information](#)

General Information:

Contact:

Location:

Web interface language: ▼

[Save settings](#) [Reset changes](#) [Back](#)

11.7.1 Administrative functions

In the first section there are several functions which may be used by the administrator. The button “Reboot LANTIME” is restarting the system, the built-in reference clock is not affected by this, only the included computer system is rebooted, which may take up to 30 seconds.

With “Manual configuration” you are able to change the main configuration by editing the configuration file by hand. After editing, press the “Save file” button to preserve your changes, afterwards you are asked if your changes should be activated by reloading the configuration (this results in reloading several subsystems like NTPD, HTTPD etc.).

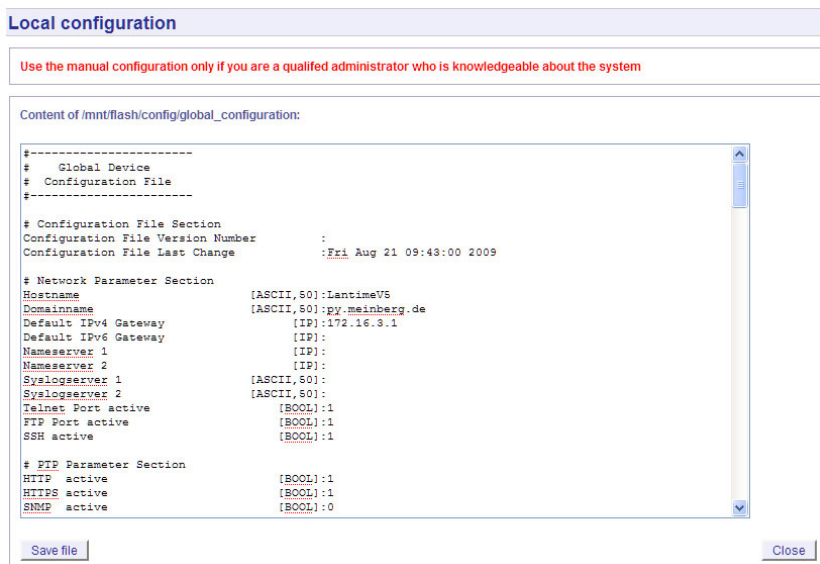

The function “Send test notification” is generating a test alarm message and sends it using all configured notify possibilities (e-mail, WMail, SNMP-Traps, wall mount display).

You can use the function “Save NTP drift file” to copy the file `/etc/ntp.drift` to the internal flash disc of your LANTIME. NTP is using this file to have the parameters for compensation of the incorrectness of the system clock available directly after a restart. This results in a faster synchronisation process of the NTPD subsystem after a system restart. You should use this function only, if the NTPD has been synchronized to the internal reference clock for more than one day. This is done here at Meinberg directly before shipping the LANTIME unit to our customers, so you do not need to use this function during normal operation. It may be applicable after a software update.

The function “Reset to factory defaults” is setting all configuration parameters back to default values. The regular file `/mnt/flash/global_configuration` will be replaced with the file `/mnt/flash/factory.conf`, but first a copy of the configuration is saved under `/mnt/flash/global_configuration.old` for backup reasons. The default password “timeserver” is replacing the actual password, too. After using this function, all certificates should be recreated because of the change of the unit’s hostname.

Please be aware of the fact that the default configuration is not activated instantly. If you want to avoid setting up the IP address of your unit by locally configuring it on site with the buttons of the front panel (meaning physical presence of someone directly at the location of the LANTIME), you have to configure the network parameters of your LANTIME immediately after using the “reset to factory defaults” button. So, please proceed directly to the Ethernet page and check/change the IP address and the possible access subsystems (HTTP for example) of the LANTIME. The first usage of “Save settings” will load the configuration from flash into memory and activate it.

The point “Download SNMP MIB files” can be used to download all Meinberg specific SNMP MIB files to your workstation. They can be distributed to all SNMP management clients afterwards.

11.7.2 User Management

For administration different users can be set up. 3 group memberships can be assigned to each user: the Super-User has all properties for administration. The group membership Administrator can change all parameters via

the command line interface (CLI) configuration tool and the WEB interface. The group Administrator cannot use any Linux command in a Telnet, SSH or Terminal session. If the Administrator will login, the setup program will be started directly. After termination of the Setup program this user will be logout automatically. The group membership "Info" has the same properties like the Administrator but cannot change any parameter.

Local configuration

Change Current User Password:

New password:

Re-enter:

User Management:

Add new User:

Password:

Group membership: Super-User
 Administrator
 Info

Available User:

Username	Group membership	Option
root	Super-User	

The menu "User Management" allows you to set up different users with a password and the group membership. To change the properties of an user you have to delete the old user and set up a new one. The user "root" cannot be deleted and has always the membership of Super-User. The password of the user "root" can be set on the security page.

11.7.3 Administrative Information

The button "List all messages" displays the SYSLOG of the LANTIME completely. In this log all subsystems create their entries, even the OS (upper case) kernel. The SYSLOG file /var/log/messages is only stored in the system's ram disk, therefore it is lost after a power off or restart. If you configured an external SYSLOG server, all LANTIME syslog entries will be duplicated on this remote system and can be saved permanently this way.

```

Mar 15 13:35:17 LanGpsV4 ntpd[12948]: ntpd 4.2.0@1.1161-r Fri Mar 5 15:58:48 CET 2004 (3)
Mar 15 13:35:17 LanGpsV4 ntpd[12948]: signal_no_reset: signal 13 had flags 4000000
Mar 15 13:35:17 LanGpsV4 ntpd[12948]: precision = 3.000 usec
Mar 15 13:35:17 LanGpsV4 ntpd[12948]: kernel time sync status 2040
Mar 15 13:35:17 LanGpsV4 ntpd[12948]: frequency initialized 45.212 PPM from /etc/ntp.drift
Mar 15 13:38:36 LanGpsV4 lantime[417]: NTP sync to GPS
Mar 15 13:38:36 LanGpsV4 lantime[417]: NTP restart
Mar 15 13:45:36 LanGpsV4 proftpd[14061]: connect from 172.16.3.2 (172.16.3.2)
Mar 15 14:01:11 LanGpsV4 login[15711]: invalid password for 'root' on 'tty1' from '172.16.3.45'
Mar 15 14:01:17 LanGpsV4 login[15711]: root login on 'tty1' from '172.16.3.45'

```

With "List detailed version information" a number of version numbers (including LANTIME software, operating system and NTPD) are shown in a textbox.

Local configuration

Content of /device_version:

```
ID: lantime ELX800 GPS170 M3x V5.28g
S/N: n/a
GPS170 :1.19 S/N: 10012290
Oscillator type: TCXO HQ
NTP Version: 4.2.0b@1.1498-o Mon Oct 6 13:18:28 UTC 2008 (1)
Kernel Version: 2.6.15.1
System Version: 528
ETH0: HWaddr 00:13:95:02:C2:FA
```

Close

The function “List LANTIME Options” shows the hardware options installed in your LANTIME.

Local configuration

Content of /mnt/flash/config/global_option:

```
#GLOBAL OPTIONS
NUMBER ETHERNET INTERFACES: 2
SYSTEM LAYOUT: 0
SYSTEM ADV LAYOUT: 0
SYSTEM LANGUAGE: 0
SYSTEM PARAMETER: server
SYSTEM DESIGN: 0
PTP PARAMETER:
REDUNDANT POWER SUPPLY:
NOTIFICATIONS:
ADV HTTP OPTION:
```

Close

Using the button “List detailed GPS information” gives you the possibility to check detailed GPS status information. The first parameter indicates the time and date of the last update of the shown parameters. Next you find the GPS receiver status and the NTP status, followed by the GPS position data. The position uses the Latitude / Longitude / Altitude format. Latitude and Longitude are shown in degrees, minutes and seconds, Altitude is shown in meters above WGS84 ellipsoid.

The satellite section shows the numbers of satellites in view and the number of usable satellites (“good SV”). Additionally, the selected set of the four used satellites can be read.

Local configuration

Content of /gps_info:

```
GPS Information File
Updated: Fri Aug 21 11:38:30 2009

GPS Mode      : NORMAL OPERATION
GPS           : sync

NTP           : Offs. PPS: 1us

Position:
Lat: 51.9828
Lon: 9.2257
Alt: 175m

Satellite:
in view : 10
good SV : 9
selected: 22 09 17 15

Dilution of Prec:
PDOP: 2.28
TDOP: 1.08

SV-Info:
Satellite 09 Info: EL: 82° AZ: 113° Dopp: -0.688 kHz
Satellite 12 Info: EL: 57° AZ: 241° Dopp: 1.847 kHz
Satellite 14 Info: EL: 25° AZ: 315° Dopp: 2.856 kHz
```

Close

The accuracy of the calculated receiver position and time deviation is dependent on the constellation of the four selected satellites. Using the position of the receiver and the satellites, a number of values can be calculated, which allow a rating of the selected constellation. These values are called “Dilutions of Precision (DOP)”. PDOP is the abbreviation for “Position Dilution of Precision”, TDOP means “Time Dilution of Precision” and GDOP stands for “General Dilution of Precision”. Lower values are indicating better accuracy.

The next section “Satellite Info” shows information about all the satellites, which are in view momentarily. The satellite ID, elevation, Azimuth and distance to the receiver reveal the position of the satellite in the sky. The Doppler shows whether the satellite is ascending (positive values) or descending (negative value).

11.7.4 Software Update

If you need to update the software of your LANTIME, you need a special file from Meinberg, which can be uploaded to the LANTIME by first choosing the file on your local computer with the "Browse" button and then press "Start firmware update".

The chosen file will be uploaded to the LANTIME, afterwards you are prompted to confirm the start of the update process. The scope of the update only depends on the chosen file.

11.7.5 Automatic configuration check

All parameters of the LANTIME can be checked for plausibility and all configured servers (e.g. SYSLOG servers, nameservers) are tested for reachability. All red coloured values should be reviewed by the administrator. Because all configured hostnames / IP addresses of the servers are processed during the reachabilitytests, the whole check process may take a while.

Local configuration		
Checking the configuration		
Ethernet:		
Hostname:	LantimeV5	ok
IPv4 Gateway:	172.16.3.1	ok
Ethernet interface 0:		
TCP/IP address:	0.0.0.0	ok
Netmask:	255.255.255.000	ok
Ethernet interface 1:		
TCP/IP address:	0.0.0.0	ok
Netmask:	255.255.255.000	ok
Notification:		
To address:	jens.bal@meinberg.de	ok
From address:	jens.bal@meinberg.de	ok
Checking the reachability of configured ip-addresses or hostnames		
Ethernet:		
IPv4 Gateway:	172.16.3.1	reacha
Notification:		
Back		

11.7.6 Get Diagnostics Information

The diagnostics information is a set of configuration parameters and files stored in a packed text file. With the help of these informations the technical support from Meinberg can reproduce the current state of your LANTIME. It takes some time to collect all information from the LANTIME. Do not press the button again while this process is running - some web browsers will cancel the job if you press the button twice. After that you can download the packed file "config.zip" to your local computer. If you have any questions or problems with your LANTIME please send this file "config.zip" as an attachment of an e-mail to Meinberg support and describe your problem.

11.7.7 Receiver Information

Here you can indicate all important and relevant information about the used receiver / radio clock.

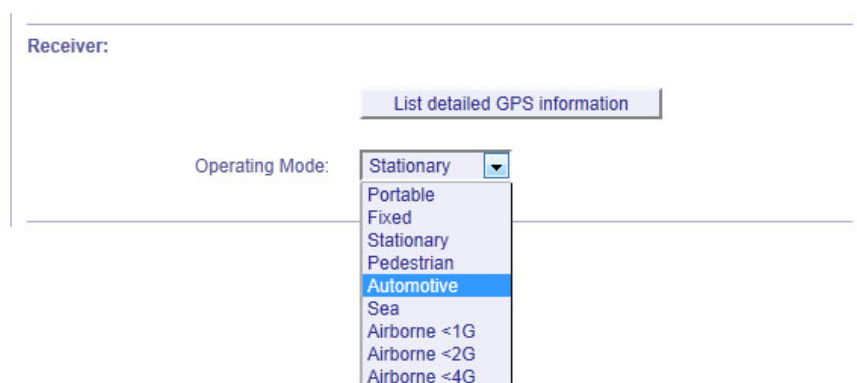

Receiver:

List detailed GPS information

Operating Mode: Stationary

- Portable
- Fixed
- Stationary
- Pedestrian
- Automotive
- Sea
- Airborne <1G
- Airborne <2G
- Airborne <4G

The example shows the menu with a GPS receiver and MGR module. With the button "List detailed GPS information" you can open a text field with all relevant receiver information. A LANTIME server with GPS receiver and MGR module can be adjusted to its operational mode (appropriate environment) - computing the position to the expecting speed.

11.7.8 Web interface language

With the selector box "Web interface language" you can change the displayed language of the WEB interface.



Web interface language: English

- English
- German

11.8 Configuration: Statistics

NTP Statistics

Statistical information:

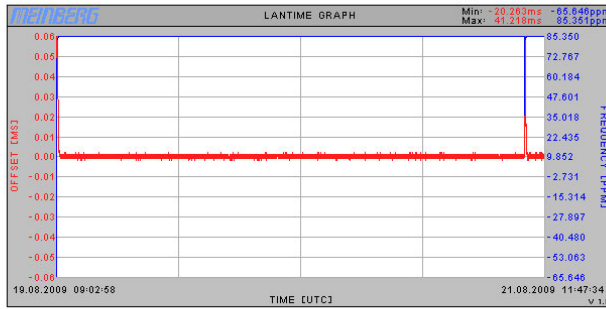

Available logfiles:

loopstats Generate graph Download statistic files
 merge statistic files

Lantime information:

S/N: n/a
 GPS170 :1.19 S/N: 10012290
 Oscillator type: TCXO HQ
 NTP Version: 4.2.0b@1.1438-o Mon Oct 6 13:18:28 UTC 2008 (1)
 Kernel Version: 2.6.15.1
 System Version: 528
 ETH0: HWaddr 00:13:95:02:C2:FA
 Uptime: 50 h
 Mem free: 30920 kB
 Disk free: 48624 kB

Output of "ntpq -p":

remote	refid	st	t	when	poll	reach	delay	offset	jitter
LOCAL(0)	LOCL.	12	I	2	16	377	0.000	0.000	0.002
+GENERIC(0)	.GPS.	0	I	5	16	377	0.000	0.000	0.002
oPPS(0)	.PPS.	0	I	12	16	377	0.000	0.000	0.002

Output of "ntpq -c 'cv assID' ":

```

assID=53410 status=0000 clk_okay, last_clk_okay,
device="Meinberg GPS16x receiver",
timecode="v0221.08.09; 5; 13:47:46; +02:00; S; 51.9828N 9.2258E 173miv03v00",
poll=215, noreply=0, badformat=0, baddata=0, fudgetime1=4.400,
stratum=0, refid=GPS, flags=0,
refclock_ppstime="ce3907e2.00000b4a Fri, Aug 21 2009 11:47:46.000",
refclock_time="ce3907e2.00000000 Fri, Aug 21 2009 11:47:46.000",
refclock_status="TIME CODE; PPS; POSITION; (LEAP INDICATION; PPS SIGNAL; POSITION)",
refclock_format="Meinberg GPS Extended",
refclock_states="NOMINAL: 00:58:27 (100.00%); running time: 00:58:27"
    
```

NTP access information:

remote address	port	local address	count	m	ver	code	avglen	last
127.0.0.1	2880	127.0.0.1	5769	7	2	0	0	0
172.16.3.116	123	172.16.3.153	55	3	4	0	64	1

Number of clients: 2

[Back](#)

[\[top \]](#)

11.8.1 Statistical Information

In the first section a graphical diagram shows the running synchronisation process. NTP is storing this statistical information in so-called "loopstats" files, which are used here to draw the curves. The red line is describing the offset between the internal reference clock (GPS) and the system clock. The blue line shows the frequency errors of the system time (in PPM, parts per million). In the upper right corner of the diagram you will find the measurement range of the red and blue curve. The last 24 hours are shown initially, but you are able to select the last 10 days (or fewer days, depending on the system uptime) or switch to a "merge loopstats" diagram, which shows all available days in one diagram (with a maximum of 10 days). All time data is using UTC.

The next sections shows version information for a number of subsystems, including the OS kernel version, NTPD version and the GPS firmware revision of the internal reference clock. Additionally, the MAC address of the first Ethernet interface can be found here. The "Mem free" value is indicating the free memory available to the system, the Disk free value is related to the ram disk of the LANTIME. Both system memory and ram disk have a total capacity of 32 MB (each). The Uptime parameter displays the time since the last boot process of the unit.

In the next section all NTP clients accessing the NTP server are listed. This list is maintained internally by NTPD, clients who did not access the NTPD for a longer period are automatically removed. This section can grow very long in large networks. There are no further information found about the parameters "code, avglen and first. The name resolution of the IP address in the first column will take too much time; so its disabled.

After that a list of all actually refclocks of the internal NTP server will be shown.

remote	refid	st	t	when	poll	reach	delay	offset	jitter
LOCAL(0)	LOCAL(0)	3	l	36	64	3	0.00	0.000	7885
lantime	.GPS.	0	l	36	64	1	0.00	60.1	15875

with the following meaning:

-
- remote: list of all valid time servers (ntp.conf)
 - refid: reference number
 - st: actual stratum value (hierarchy level)
 - when: last request (seconds)
 - poll: period of requesting the time server (seconds)
 - reach: octal notation of the successful requests, shifted left
 - delay: delay of the network transmission (milliseconds)
 - offset: difference between system time and reference time (milliseconds)
 - jitter: variance of the offsets (milliseconds)

The last section will show some NTP specific informations about the refclock.

11.9 Configuration: Manual

Manual

Available documents:

Filename	Language	Type	Date	Size	Option
1he_langps_etx_v5_e	english	pdf	2009-02-27	1647.40kb	open
1he_langps_etx_v5	german	pdf	2009-02-27	1745.07kb	open

2 documents available

You need Adobe's Acrobat Reader to open most of the documents [open](#)

Customer notes:

Filename	Language	Type	Date	Size	Options
no notes available	n/a	n/a	n/a	n/a	n/a

[Add note](#)

[Back](#)

This page gives you access to the documents stored on your LANTIME, especially the manuals and your own notes. The two lists include filename, language, file type, date and size of the documents/notes.

The LANTIME documents can be downloaded from here in order to read / print them on your workstation. The customer notes are a way of storing small pieces of information on your LANTIME, for example if you want to keep track of configuration changes and want to comment them, you can create a note called "config_changes" and show or edit it from here. If you want to get rid of one of your notes, you are able to delete it by choosing the appropriate button.

Manual

Content of /www/manual/customer/english/history.txt:

```
12.08.2009 - Start LANTIME Time Service
20.08.2009 - Firmware Update
```

[Save file](#) [Close](#)

If you want to add a note (you can maintain more than one note on your LANTIME), after choosing the button "add note" you have to enter a filename (without a directory path, all notes are stored in a fixed directory on the flash disk of your LANTIME) and the language of your note first. After you confirmed these parameters with "Add document", you are able to edit the text of your new note.

11.10 Configuration: PTP

In the PTP section, all parameters of the PTP subsystem can be configured. The current state can be monitored as well. When operating in SLAVE mode (as with MRS devices), a graphical representation of the offset and the path delay to the grandmaster will be shown:

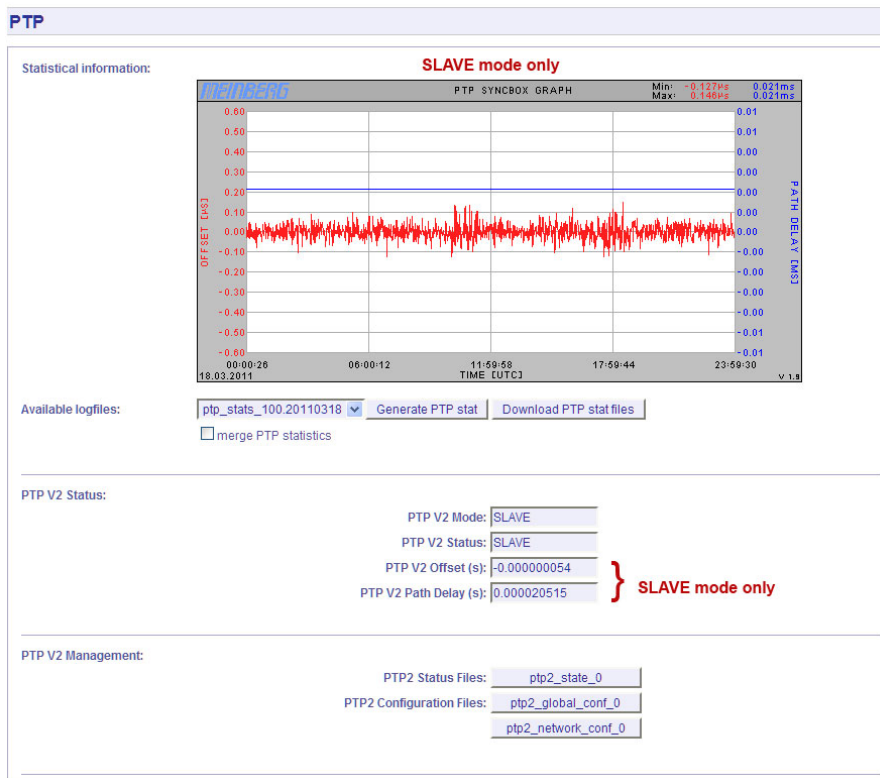

- In the PTP V2 Management menu section you can view the current PTP state by displaying the "ptp2_state_0" file (see 11.10.4).
- All configuration parameters of the PTP unit can be viewed and changed by editing the "ptp2_global_conf_0" file (see 11.10.1).
- The IP address and VLAN configuration can be edited by altering the "ptp2_network_config_0" file (see 11.10.3).
- If more than one PTP unit is built into the system, then the configuration for each port can be edited separately and will be listed on this page. A detailed description of the parameters can be found in chapter 11.10.1 (Global PTP Parameters).

11.10.1 PTPv2 - Global Configuration

Parameter	Value	Description
PTP Mode	[NUM]	0=Multicast (MC), 1=Unicast (UC)
PTP is slave	[BOOL]	1=Slave only, 0=Grandmaster only
PTP Delay Mechanism	[0,1]	0=End-to-End, 1=Peer-to-Peer
PTP V1 Hardware Compatibility	[0,1]	PTP packet length as in PTPv1 standard (0=default)
PTP Domain Number	[NUM,0:255]	A domain is logical group of PTP devices
PTP Network Protocol	[NUM,1,3]	1=UDP/IPv4 (L3), 3=IEEE 802.3 (L2)
PTP Timescale	[NUM,0:1]	0=ARB, 1=PTP (default)
PTP priority1	[NUM:0:255]	Priority1 as used in Best Master Clock Algorithm
PTP priority2	[NUM:0:255]	Priority2 as used in Best Master Clock Algorithm
PTP Sync Interval	[2 ^x]:0	used in MC Master or UC Slave mode
PTP Announce Interval	[2 ^x]:1	used in MC Master or UC Slave mode
PTP DelayRequest Interval	[2 ^x]:3	used in MC Master or UC Slave mode
PTP Unicast interval duration [s]	[NUM]:60	Requested duration until timeout/renewal
PTP Unicast clockid of master	[ASCII,50]	Unicast: Master Clock ID (default: FF:FF:FF:FF:FF:FF:FF:FF as wildcard)
PTP Unicast IP address of master	[IP]	Unicast: IP address of Grandmaster (e.g. 172.29.9.236)
Feature Presets	[NUM]	1=Power Profile Preset, 2=Telecom Profile Preset
Power Profile Grandmaster ID	[NUM,3:254]:0	ID of Grandmaster, 3 - 254 (Power Profile only)
Power Profile Network Inaccuracy	[NUM]:0	accumulated time inaccuracy in worst network path in ns (Power Profile only)
User defined Fix Offset positive	[BOOL]	1=Positive PTP Phase shift to RefTime
User defined Fix Offset [ns]	[NUM]	Phase shift to RefTime (0..1000000 ns)
HQ Filter active	[BOOL]:0	Slave: Optimized filter for high load/jitter
HQ Filter estimated accuracy [ns]	[NUM]:5000	estimated accuracy of HQ Filter,maximum jitter in network
PDSC active	[BOOL]:0	Path Delay Step Compensation (Filter on) (see also chapter ??)
PTP Announce Receipt Timeout	[2 ^x]:3	only used with Mulicast Master mode

11.10.2 Option: PTP Client Monitoring

From Lantime Firmware Version 5.34m onwards

The PTP Client-Monitor can be configured via Front Panel **Time Service -> PTP IEEE1588 -> Setup PTP0 IEEE1588 V2 -> PTP Settings -> PTP Parameters -> PTP Client Management** (for configuration see the chapter on User Interfaces) and via Web Interface. In the Front-Panel maximum seven nodes (PTP Clients) can be displayed. Therefore, for a complete overview the usage of the Web Interface is advised.

By selecting the **ptpmmm_0.log** button more than 100 PTP nodes can be listed. The list of PTP nodes with their current status information has the following form:

```
# PTP Client Management: found 6 PTP nodes
#
#   UUID                State-Txt   -Val  Offset                Pathdelay            Alias
#-----
#   EC4670FFFE0024CC    SLAVE      9     -0.000000015         0.000010420          alias_0
#   EC4670FFFE002435    MASTER     6     0.000000000          0.000000000
#   0050C2FFFE0B717EA    SLAVE      9     0.000000146          0.000020675          alias_2
#   0050C2FFFE0D287DE    SLAVE      9     0.000000107          0.000020859          alias_3
#   EC4670FFFE000801    PASSIVE    7     0.000000000          0.000000000
```

Prior to one or more PTP nodes monitoring, a list of the PTP clients needs to be generated. The list can be displayed and edited via Web Interface with the **ptp2_client_management_list_of_uuids_0** button.

Each line corresponds to one of the PTP node being monitored. The line format correlates to the node's status-info in "ptpmmm_0.log" (see above). Therewith it is possible to copy the line with a desired PTP node from the status-info with "Copy" and "Paste" it to the PTP client list.

```
#   UUID                State text   val   offset                pathdelay            Alias
#   0050C2FFFE0D287DE    Slave       9     0.000000500          0.000025000          alias_name
```

The first value is a so-called PTP UUID, which consists mainly of the MAC address and a fixed "FFFE" middle part as follows: **XX XX XX FF FE XX XX XX**

Both next values correspond to PTP status as a text and a value. The following status values are possible:

SLAVE	9
MASTER	6
PASSIV	7

If the PTP status is equal to SLAVE, the maximal offset and the maximal pathdelay to a PTP Master can be added additionally as limit threshold values. For each PTP node the following conditions are also being checked:

1. Accessibility
2. PTP Status
3. If PTP Status = SLAVE: exceeding a given maximal absolute offset value (related to the PTP Master).
4. If PTP Status = SLAVE: exceeding a given maximal pathdelay value (related to the PTP Master).

The current status conditions are forwarded to the Notification Triggers respectively via "PTP State changed" notification. All notifications are triggered only once until the state changes in the following way:

1. A node is again accessible.
2. PTP Status has changed again.
3. Offset value is below a given threshold again.
4. Pathdelay is below a given threshold again.

Menu Notification

Notification conditions:

PTP State changed	<input type="checkbox"/>	<input type="checkbox"/>	<input type="checkbox"/>	<input type="checkbox"/>	<input type="checkbox"/>	<input type="checkbox"/>
-------------------	--------------------------	--------------------------	--------------------------	--------------------------	--------------------------	--------------------------

11.10.3 PTP Network Configuration

All network configurations of the selected PTP interface can be done with this menu:

The screenshot shows a window titled "PTP" with a text area containing the following configuration file content:

```

Inhalt von /etc/jtp2/jtp2_network_conf_0:

#-----
#   PTP2 Network
#   Configuration File
#-----
# Hostname for PTP port
Hostname [ASCII,50]:PTPv2
# Domainname for PTP port
Domainname [ASCII,50]:
#
Nameserver 1 [ASCII,50]:
#
Nameserver 2 [ASCII,50]:
# IP address of PTP port
TCPIP address [IP]:192.168.100.10
# Netmask of PTP port
NETMASK [IP]:255.255.255.0
# IP address of PTP port
Default Gateway [IP]:192.168.100.1
# Enable DHCP client

```

Buttons at the bottom of the window are "Datei speichern" and "Schließen".

Content of the PTP Network Configuration File:

Parameter	Value	Description
Hostname	[ASCII,50]:PTPv2	Hostname for PTP port
Domainname	[ASCII,50]:	Domainname for PTP port
Nameserver 1	[ASCII,50]:	
Nameserver 2	[ASCII,50]:	
TCPIP address	[IP]:192.168.100.10	IP address of PTP port
NETMASK	[IP]:255.255.255.0	Netmask of PTP port
Default Gateway	[IP]:192.168.100.1	Gateway
DHCP CLIENT	[BOOL]:0	1=Activate DHCP client
Vlan enabled	[BOOL]:0	Enable Virtual LAN interface (IEEE 802.1Q)
Vlan ID	[NUM]:	VLAN ID for virtual interface
Vlan Priority	[NUM]:	VLAN priority for virtual interface
PTP IP TTL	[NUM]:	Multicast IP Packet Time To Live (TTL default:5)

11.10.4 PTP State Files

In diesem Menü werden alle Statusinformationen der gewählten TSU angezeigt:

PTP

Inhalt von /etc/ptp2/ptp2_state_0:

```

PTP Mode           : MASTER
Domain number      : 0
Network Protocol   : UDP/IPv4
PTP DelayMech      : E2E
Current Port State : MASTER
BMC Priority 1     : 128
BMC Priority 2     : 128
Sync Intervall 2^x: 0
Ann. Intervall 2^x: 1
PTP LogDelayReq   : 3
OCMO BQ Mode       : disabled
Clock class        : 52
Clock accuracy     : 254
Clock variance     : 13565
Grandmaster MAC   : 00:60:6E:7C:23:16
Number of clients  : 0
Number of masters  : 0
PTP Port Link up   : 1
IPv4 address       : 192.168.100.10
Netmask            : 255.255.255.0
Gateway            : 192.168.100.1
Local Mac Address  : 00:60:6E:7C:23:16
PTP seconds        : 1299755044
PTP timescale      : PTP (TAI)
PTP time source    : Internal Oscillator
PTP UTC Offset     : 34
  
```

Schließen

```

PTP Mode           : [MASTER,SLAVE]
Domain number      : [0..3]
Network Protocol   : [UDP IPv4 Layer3,IEEE 802.3 Layer 2]
PTP DelayMech      : [E2E,P2P]
Current Port State : [INITIALIZING,LISTENING,UNCALIBRATED,MASTER,
UnicastMASTER,SLAVE,UnicastSLAVE]
Clock class        : [6=RefClock Sync,7=RefClock Holdover,
52=RefClock unsynchronized,255=Slave only]
Clock accuracy     : 33 (according to enumeration list in standard)
Clock variance     : 13565 [,65535=unknown]
Grandmaster MAC   : 00:60:6E:7C:27:2C
Number of clients  : 0 (not used yet)
Number of masters  : 0 (not used yet)
PTP Port Link up   : 1
IPv4 address       : 172.29.4.10
Netmask            : 255.255.255.0
Gateway            : 172.29.4.1
Local Mac Address  : 00:60:6E:7C:27:2C
PTP seconds        : 1299849447 [raw PTP seconds]
PTP timescale      : PTP (TAI) [,ARB]
PTP time source    : GPS [NTP,PTP,Internal Oszillator, unknown]
PTP UTC Offset     : 34
PTP Leapsecond    : 0 [Announcement active]
TSU Time           : TAI:11.03.11 13:17:27.652680;
SYS Time           : UTC:11.03.11 13:16:53.655558;
  
```

12 The Command Line Interface

The command line interface (CLI) can be used within a TELNET or SSH session. After login, just enter “setup” to start the CLI setup tool.

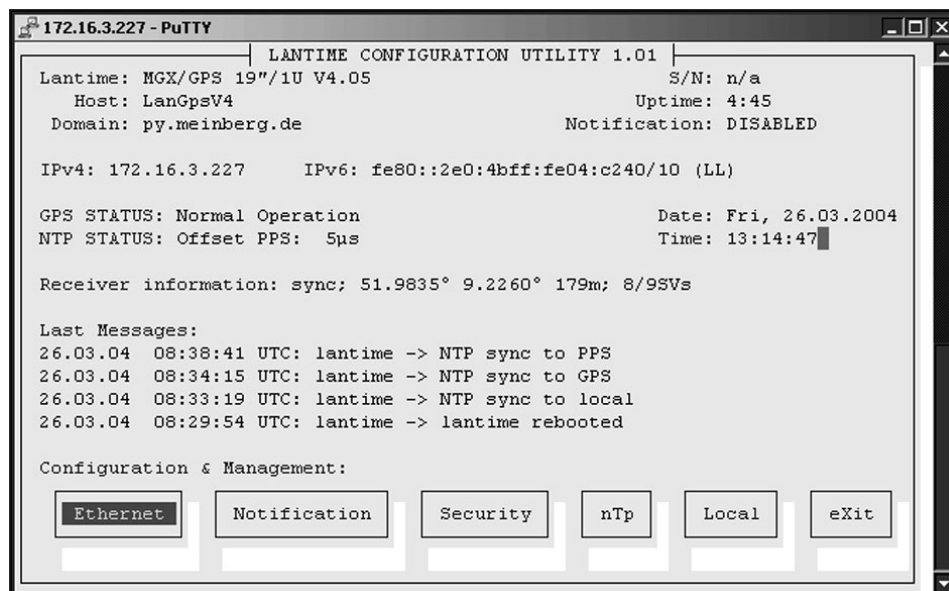

```
LANTIME CONFIGURATION UTILITY 1.01
Lantime: MGX/GPS 19"/1U V4.05          S/N: n/a
Host: LanGpsV4                        Uptime: 4:45
Domain: py.meinberg.de                Notification: DISABLED

IPv4: 172.16.3.227      IPv6: fe80::2e0:4bff:fe04:c240/10 (LL)

GPS STATUS: Normal Operation          Date: Fri, 26.03.2004
NTP STATUS: Offset PPS: 5µs          Time: 13:14:47

Receiver information: sync; 51.9835° 9.2260° 179m; 8/9SVs

Last Messages:
26.03.04 08:38:41 UTC: lantime -> NTP sync to PPS
26.03.04 08:34:15 UTC: lantime -> NTP sync to GPS
26.03.04 08:33:19 UTC: lantime -> NTP sync to local
26.03.04 08:29:54 UTC: lantime -> lantime rebooted

Configuration & Management:
Ethernet Notification Security nTp Local eXit
```

The start page gives a short overview of the most important configuration parameters and the runtime statistics of the unit. In the upper left corner you can read which LANTIME type and version of the LANTIME software you are using. This LANTIME software version is a head version number describing the base system and important subsystem. Below the version you will find the actual hostname and domain of your LANTIME unit, the IPv4 and IPv6 network address of the first network interface and on the right side the serial number, the uptime of the system (time since last boot) and the notification status is reported.

In the second section the actual status of the GPS reference clock and the NTP subsystem is shown, additional information about the GPS receiver can also be found here. This includes the number of satellites in view and the number of good satellites in view.

The third section shows the last messages of the system, each with a timestamp added. The newest messages are placed at the top of the list. This reflects the content of the file `/var/log/messages`, which is created after every start of the system (and is lost after a power off or reboot, see “Syslog server” to learn how to save the entries of your SYSLOG).

By using the buttons in the lower part of the screen, you can reach a number of configuration pages, that are described below.

12.1 CLI Ethernet

```

ETHERNET CONFIGURATION
-----
<Hostname>      LantimeV4
<Domainname>   py.meinberg.de

<Nameserver 1> 172.16.3.1
<Nameserver 2>

<Syslogserver 1>
<Syslogserver 2>

<IPv4 Default Gateway> 172.16.3.1
<IPv6 Default Gateway>

<Telnet>      ENABLED   <SSH>      ENABLED
<FTP>        ENABLED   <HTTPS>   ENABLED
<HTTP>       ENABLED   <SMB&A>   DISABLED
<IPv6 protocol:> ENABLED   <SNMP>    ENABLED

Ethernet 0      SAVE      CLOSE
  
```

In the network configuration all parameters related to the network interfaces can be changed. In the first section you can change the hostname and domain name. You can also specify two nameservers and two SYSLOG servers. In the nameserver and SYSLOG server fields you may enter an IPv4 or IPv6 address (the SYSLOG servers can be specified as a hostname, too).

All information which is written to the LANTIME SYSLOG (`/var/log/messages`) can be forwarded to one or two remote SYSLOG servers. The SYSLOG daemon of this remote SYSLOG needs to be configured to allow remote systems to create entries. A Linux SYSLOGD can be told to do so by using the command “`syslogd -r`” for starting the daemon.

If you enter nothing in the SYSLOG server fields or specify 0.0.0.0 as the SYSLOG server’s addresses, the remote SYSLOG service is not started on your LANTIME.

Please be aware of the fact that all SYSLOG entries of the timeserver are stored in `/var/log/messages` and will be deleted when you power off or reboot the timeserver. A daily CRON job is checking for the size of the LANTIME SYSLOG and deletes them automatically, if their size is exceeding a limit.

By specifying one or two remote SYSLOG servers, you can preserve the SYSLOG information even when you have to reboot or switch off the LANTIME.

In the second section the possible network protocols and access methods can be configured. You can enable/disable TELNET, FTP, SSH, HTTP, HTTPS, SNMP and NETBIOS by checking/unchecking the appropriate check box. After you saved your settings with the “Save” button, all of these subsystems are stopped and restarted (if they are enabled).

The third section allows you to select the IP protocol 6. In this version the IPv4 protocol is mandatory and cannot be disabled, but a standalone IPv6 mode can be reached by entering an IPv4 address “0.0.0.0” and disabling the DHCP client option for every network interface of your LANTIME. By doing so, you ensure that the timeserver cannot be reached with IPv4. Please note that TELNET, FTP and NETBIOS cannot be used over IPv6 in this version. IPv4 and IPv6 can be used together on one LANTIME.

To manage the interface specific parameters, you can enter the Ethernet Configuration Line page by using one of the ETHERNET buttons. If your LANTIME is equipped with only one network interface, you will find only one button (ETHERNET 0). Otherwise you see one button for each installed Ethernet port.

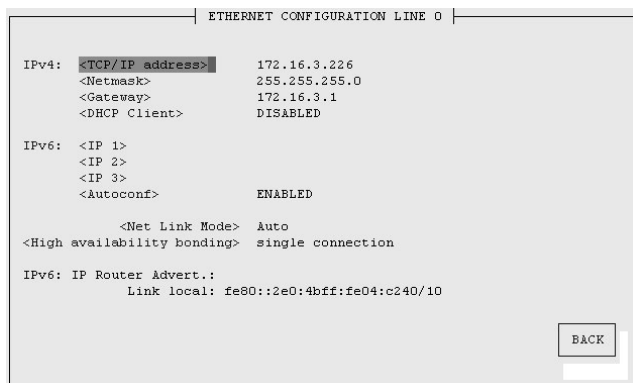

Here, the parameters for the network port can be changed. In the upper section of the page you can enter the IPv4 parameters, the lower part gives you access to the IPv6 parameters of the interface.

IPv4 addresses are built of 32 bits, which are grouped in four octets, each containing 8 bits. You can specify an IP address in this mask by entering four decimal numbers, separated by a point ".".

Example: 192.168.10.2

Additionally you can specify the IPv4 Netmask and your default gateway address. Please contact your network administrator, who will provide you with the settings suitable for your specific network.

If you are running a DHCP (Dynamic Host Configuration Protocol) server in your network, the LANTIME system can obtain its IPv4 settings automatically from this server. If you want to use this feature (you should also ask your network administrator if this is applicable in your network), you can change the DHCP Client parameter to "ENABLED". In order to activate the DHCP client functionality, you can also enter the IP address "000.000.000.000" in the LCD menu by using the front panel buttons of the LANTIME. This is the default setting.

The MAC address of your timeserver can be read in the LCD menu by pressing the NEXT button on the front panel twice. This value is often used by the network administrator when setting up the DHCP parameters for your LANTIME at the DHCP server.

If the DHCP client has been activated, the automatically obtained parameters are shown in the appropriate fields (IPv4 address, netmask, gateway).

You can specify up to three IPv6 addresses for your LANTIME timeserver. Additionally you can switch off the IPv6 AUTOCONF feature. IPv6 addresses are 128 bits in length and written as a chain of 16 bit numbers in hexadecimal notation, separated with colons. A sequence of zeros can be substituted with "::" once.

Examples:

"::" is the address, which simply consists of zeros

"::1" is the address, which only consists of zeros and a 1 as the last bit.

This is the so-called host local address of IPv6 and is the equivalent to 127.0.0.1 in the IPv4 world

"fe80::0211:22FF:FE33:4455" is a typical so-called link local address, because it uses the "fe80" prefix.

In URLs the colon interferes with the port section, therefore IPv6-IP-addresses are written in brackets in an URL: "http://[1080::8:800:200C:417A]:80/"; the last ":80" simply sets the port to 80, the default http port)

If you enabled the IPv6 protocol, the LANTIME always gets a link local address in the format "fe80:", which is based upon the MAC address of the interface. If a IPv6 router advertiser is available in your network and if you enabled the IPv6 AUTOCONF feature, your LANTIME will be set up with up to three link global addresses automatically.

The next parameter in this sub section is "Netlink mode". This controls the port speed and duplex mode of

the selected Ethernet port. Under normal circumstances, you should leave the default setting (“autosensing”) untouched, until your network administrator tells you to change it.

The standard moniker for this technology is IEEE 802.3ad, although it is known by the common names of trunking, port trunking, teaming and link aggregation. The conventional use of bonding under Linux is an implementation of this link aggregation. Only one link is used at any given time. At least two physical Ethernet ports must be linked to one bonding group to activate this feature. The first Ethernet Port in one bonding group provides the IP-Address and the net mask of this new virtual device. The implementation of the LANTIME Bonding feature will not replace the MAC address of the active ethernet port. Depending on the LINK state of the ETH-port the IP address of the first port in the bonding group will be set to the next ethernet port. All services will be restarted automatically.

At this menu point it is possible to add each Ethernet port to a bonding group. At least two physical Ethernet ports must be linked to one bonding group to activate this feature. The first Ethernet Port in one bonding group provides the IP Address and the net mask of this new virtual device.

12.2 CLI Notification

```

NOTIFICATION CONFIGURATION
Email: <To address> gregoire.diehl@meinberg.de
      <From address> LantimeGregoire
      <Smarthost> gateway
      <CC recipients> info@meinberg.de

Windows Mail: <Mail address 1>
              <Mail address 2>

SNMP: <SNMP manager 1>
      <Community>
      <SNMP manager 2>
      <Community>

Display <Display 1 address>
        <Serial number 1>
        <Display 2 address>
        <Serial number 2>

<Show user defined script> <Edit user defined script>

<Notification conditions> <SAVE> <CLOSE>

```

Alarm events

On this page you can set up different notification types for a number of events. This is an important feature because of the nature of a timeserver: running in the background. If an error or problem occurs, the timeserver is able to notify an administrator by using a number of different notification types.

The LANTIME timeserver offers four different ways of informing the administrator or a responsible person about nine different events: EMAIL send an e-mail message to a specified e-mail account, SNMP-TRAP sends a SNMP trap to one or two SNMP trap receivers, WINDOWS POPUP MESSAGE sends a Winpopup message to one or two different computers and DISPLAY shows the alarm message on a wall mount display model VP100/NET, that is an optional accessory you can obtain from us.

"NTP not sync"	NTP is not synchronised to a reference time source
"NTP stopped"	NTP has been stopped (mostly when very large time offsets occur)
"Server boot"	System has been restarted
"Receiver not responding"	No contact to the internal GPS receiver
"Receiver not sync"	Internal GPS clock is not synchronised to GPS time
"Antenna faulty"	GPS antenna disconnected
"Antenna reconnect"	GPS antenna reconnected
"Config changed"	Configuration was changed by a user
„Leap second announced“	A leap second has been announced

Every event can use a combination of those four notification types, of course you can disable notification for events by disabling all notification types. The configuration of the four notification types can be changed in the upper section of the page, you can control which notification is used for which event by using the button “notification conditions” in the lower part of the page.

E-mail messages

You can specify the e-mail address which is used as the senders address of the notification e-mail (From: address), the e-mail address of the receiver (To: address) and a SMTP smarthost, that is a mail server who is forwarding your mail to the receiver. If your LANTIME system is connected to the internet, it can deliver those e-mails itself. Additional e-mail recipients can be configured with the button "CC recipients". These settings cannot be altered with the LC display buttons of the front panel.

Please note the following:

- The LANTIME hostname and domain name should be known to the SMTP smarthost
- A valid nameserver entry is needed
- The domain part of the From: address has to be valid

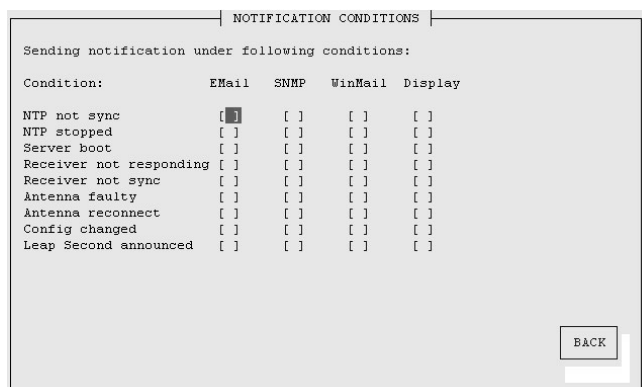

Windows Popup Messages

Most Microsoft Windows operating systems provide you with a local notification tool.

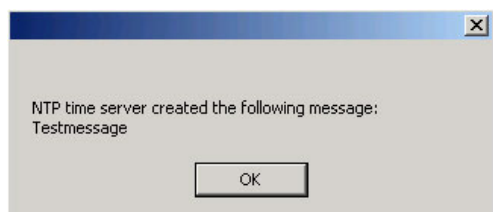

You can send messages via the special Windows protocol in your local network. It is not necessary to enable the NETBIOS protocol of the LANTIME in order to use this notification. On the Windows client side it is necessary to activate the "Microsoft Client for Windows" in the network configuration.

You can enter the Windows computer name of up to two Windows PCs in the appropriate fields. Every message contains a time stamp and a plain text message:

SNMP-TRAP messages

Up to two SNMP trap receiver hosts can be configured in this subsection, you may use IPv4 or IPv6 addresses or specify a hostname. Additionally you have to enter a valid SNMP community string for your trap receiving community. These are mostly independent from the SNMP community strings used for status monitoring and configuration (see SNMP configuration on the "Security" page).

VP100/NET wall mount display

The VP100/NET wall display is an optional accessory for the LANTIME timeserver, it has an own integrated Ethernet port (10/100 Mbit) and a SNTP client. The time of the display can be received from any NTP server using the SNTP protocol, additionally the display is able to show text messages, which are sent by using special software. The LANTIME can send an alarm message to one or two VP100/NET displays over the network, whenever an event occurs, for which you selected the display notification type. An alarm message is shown three times as a scrolling message.

Just enter the display's IP address and its serial number (this is used for authorization), which can be found by pressing the red SET button on the back of the display four times. The serial number consists of 8 characters, representing four bytes in hexadecimal notation.

If you want to use the display for other purposes, you can send text messages to it by using our command line tool send2display, which can be found on the LANTIME. This allows you to use the display by CRON jobs or your own shell scripts etc. If you run the tool without parameters, a short usage screen is shown, explaining all parameters it may understand. See appendix for a printout of this usage screen.

NTP Client Monitoring

You can monitor a group of NTP clients and supervise the time offset, the NTP stratum value and if the client is reachable or not. With the button „edit client list“ you can edit the list of clients to monitor. You can add the TCP/IP address or the hostname of the client:

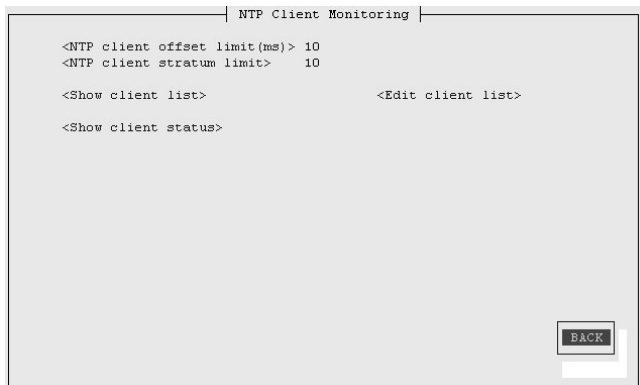

You can monitor the current states of the configured clients:

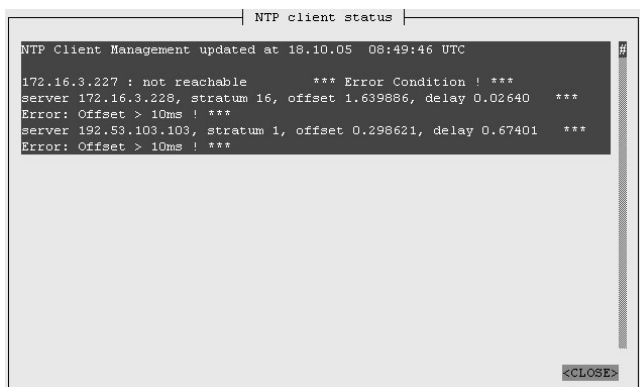

12.3 CLI Security

On the "Security" page you can manage all security relevant parameters for your timeserver. In the first section "Login" the administration password can be changed, which is used for SSH, TELNET, FTP, HTTP and HTTPS access.

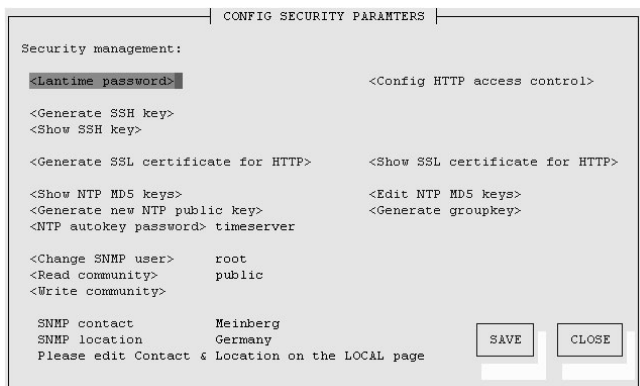

The password is stored encrypted on the internal flash disk and can only be reset to the default value "timeserver" by a "factory reset", changing all settings back to the factory defaults. Please refer to the LCD configuration

section in this manual.

SSH Secure Shell Login

The SSH provides you with a secure shell access to your timeserver. The connection is encrypted, so no readable passwords are transmitted over your network. The actual LANTIME version supports SSH1 and SSH2 over IPv4 and IPv6. In order to use this feature, you have to enable the SSHD subsystem and a security key has to be generated on the timeserver by using the “Generate SSH key” button. Afterwards, a SSH client can connect to the timeserver and opens a secure shell:

```
ssh root @ 192.168.16.111
```

The first time you connect to a SSH server with an unknown certificate, you have to accept the certificate, afterwards you are prompted for your password (which is configured in the first section of this page). If you generate a new SSH key, you can copy and paste it into your SSH client configuration afterwards in order to allow you to login without being prompted for a password. We strongly recommend to use SSH for shell access, TELNET is a very insecure protocol (transmitting passwords in plain text over your network).

If you enabled SSH, your LANTIME automatically is able to use secure file transfer with SCP or SFTP protocol. The usage of FTP as a file transfer protocol is as insecure as using TELNET for shell access.

Generate SSL Certificate for HTTPS

HTTPS is the standard for encrypted transmission of data between web browser and web server. It relies on X.509 certificates and asymmetric crypto procedures. The timeserver uses these certificates to authenticate itself to the client (web browser). The first time a web browser connects to the HTTPS web server of your LANTIME, you are asked to accept the certificate of the web server. To make sure that you are talking to your known timeserver, check the certificate and accept it, if it matches the one stored on the LANTIME. All further connections are comparing the certificate with this one, which is saved in your web browser configuration. Afterwards you are prompted to verify the certificate only when it changed.

By using the button “Generate SSL certificate for HTTP” you can create a new certificate. Please enter your organisation, name, mail address and the location in the upcoming form and press “Generate SSL certificate” to finally generate it.

NTP keys and certificates

The fourth and fifth section of the “Security” page allow you to create the needed crypto keys and certificates for secure NTP operation (please see NTP authentication below).

The function “Generate new NTP public key” is creating a new self-signed certificate for the timeserver, which is automatically marked as “trusted”.

Important note: This certificate is depending on the hostname of your LANTIME, it is mandatory to recreate the certificate after changing the hostname. The certificates are build with the internal command “ntp-keygen -T” (ntp-keygen is part of the installed NTP suite). Your LANTIME is using the /etc/ntp/ directory for storing its private and public keys (this is called the “keysdir”). Please refer to the chapter “NTP Autokey” for further information (below).

The two options “Show NTP MD5 key” and “Edit NTP MD5 keys” allow you to manage the symmetric keys used by NTP. More about that can be found in the chapter about symmetric keys (below).

12.4 CLI NTP Parameter

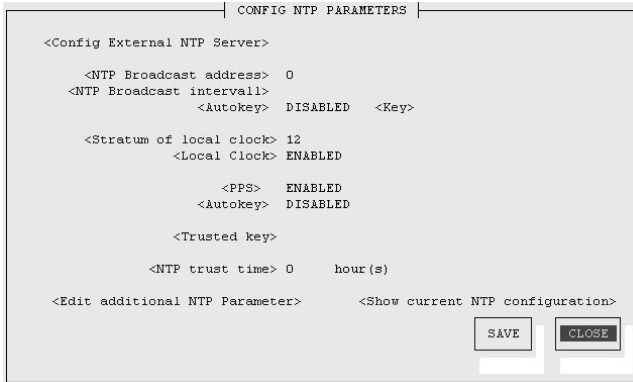

The NTP configuration page is used to set up the additional NTP parameters needed for a more specific configuration of the NTP subsystem.

The default configuration of the timeserver consists of a local clock, which represents the hardware clock of your LANTIME system and the GPS reference clock. The local clock is only chosen as the NTP time reference after the GPS clock lost its synchronisation. The stratum level of this local clock is set to 12, this ensures that clients recognise the switchover to the local clock and are able to eventually take further actions. The local clock can be disabled.

Because the GPS reference clock is internally connected to the LANTIME system by using a serial connection, the accuracy using this way of synchronisation is around 1 ms. The high accuracy of the LANTIME timeserver (around 10 microseconds) is available by using the ATOM driver of the NTP subsystem, which is directly interpreting the PPS (pulse per second) of the GPS reference clock. The default configuration looks like this:

```
# *** lantime ***
# NTP.CONF for GPS167 with UNI ERLANGEN

server      127.127.1.0          # local clock
fudge       127.127.1.0 stratum 12 # local stratum
server      127.127.8.0 mode 135 prefer # GPS167 UNI Erlangen PPS
fudge       127.127.8.0 time1 0.0042 # relative to PPS
server      127.127.22.0        # ATOM (PPS)
fudge       127.127.22.0 flag3 1 # enable PPS API

enable stats
statsdir /var/log/
statistics loopstats
driftfile /etc/ntp.drift

# Edit /mnt/flash/ntpconf.add to add additional NTP parameters
```

12.4.1 CLI NTP Authentication

Please see the corresponding chapter in the web interface description.

12.5 CLI Local

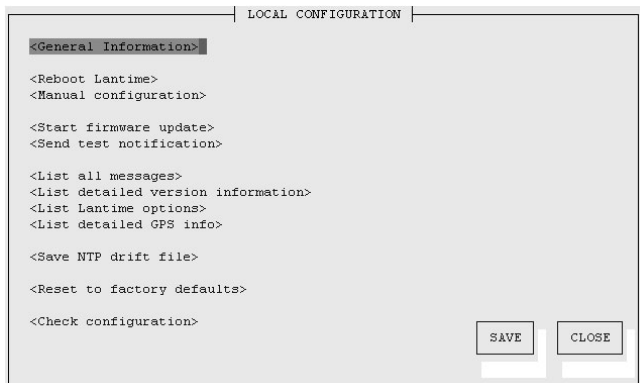

Administrative functions

In the first section there are several functions which may be used by the administrator. The button "Reboot LAN-TIME" is restarting the system, the built-in reference clock is not affected by this, only the included computer system is rebooted, which may take up to 30 seconds.

With "Manual configuration" you are able to change the main configuration by editing the configuration file by hand. After editing, press the "Save file" button to preserve your changes, afterwards you are asked if your changes should be activated by reloading the configuration (this results in reloading several subsystems like NTPD, HTTPD etc.).

The function "Send test notification" is generating a test alarm message and sends it using all configured notify possibilities (e-mail, WMail, SNMP-Traps, wall mount display).

You can use the function "Save NTP drift file" to copy the file `/etc/ntp.drift` to the internal flash disc of your LANTIME. NTP is using this file to have the parameters for compensation of the incorrectness of the system clock available directly after a restart. This results in a faster synchronisation process of the NTPD subsystem after a system restart. You should use this function only, if the NTPD has been synchronized to the internal reference clock for more than one day. This is done here at Meinberg directly before shipping the LANTIME unit to our customers, so you do not need to use this function during normal operation. It may be applicable after a software update.

The function "Reset to factory defaults" is setting all configuration parameters back to default values. The regular file `/mnt/flash/global_configuration` will be replaced with the file `/mnt/flash/factory.conf`, but first a copy of the configuration is saved under `/mnt/flash/global_configuration.old` for backup reasons. The default password "timeserver" is replacing the actual password, too. After using this function, all certificates should be recreated because of the change of the unit's hostname.

Please be aware of the fact that the default configuration is not activated instantly. If you want to avoid setting up the IP address of your unit by locally configuring it on site with the buttons of the front panel (meaning physical presence of someone directly at the location of the LANTIME), you have to configure the network parameters of your LANTIME immediately after using the "reset to factory defaults" button. So, please proceed directly to the Ethernet page and check/change the IP address and the possible access subsystems (HTTP for example) of the LANTIME. The first usage of "Save settings" will load the configuration from flash into memory and activate it.

User Management

For administration different users can be set up. 3 group memberships can be assigned to each user: the Super-User has all properties for administration. The group membership Administrator can change all parameters via the command line interface (CLI) configuration tool and the WEB interface. The group Administrator cannot use any Linux command in a Telnet, SSH or Terminal session. If the Administrator will login, the setup program

will be started directly. After termination of the Setup program this user will be logout automatically. The group membership "Info" has the same properties like the Administrator but cannot change any parameter. The menu "User Management" allows you to set up different users with a password and the group membership. To change the properties of an user you have to delete the old user and set up a new one. The user "root" cannot be deleted and has always the membership of Super-User. The password of the user "root" can be set on the security page.

Administrative information

The button "List all messages" displays the SYSLOG of the LANTIME completely. In this log all subsystems create their entries, even the OS kernel. The SYSLOG file /var/log/messages is only stored in the system's ram disk, therefore it is lost after a power off or restart. If you configured an external SYSLOG server, all LANTIME SYSLOG entries will be duplicated on this remote system and can be saved permanently this way.

```
Mar 15 13:35:17 LanGpsV4 ntpd[12948]: ntpd 4.2.0@1.1161-r Fri Mar 5 15:58:48 CET 2004 (3)
Mar 15 13:35:17 LanGpsV4 ntpd[12948]: signal_no_reset: signal 13 had flags 4000000
Mar 15 13:35:17 LanGpsV4 ntpd[12948]: precision = 3.000 usec
Mar 15 13:35:17 LanGpsV4 ntpd[12948]: kernel time sync status 2040
Mar 15 13:35:17 LanGpsV4 ntpd[12948]: frequency initialized 45.212 PPM from /etc/ntp.drift
Mar 15 13:38:36 LanGpsV4 lantime[417]: NTP sync to GPS
Mar 15 13:38:36 LanGpsV4 lantime[417]: NTP restart
Mar 15 13:45:36 LanGpsV4 proftpd[14061]: connect from 172.16.3.2 (172.16.3.2)
Mar 15 14:01:11 LanGpsV4 login[15711]: invalid password for 'root' on 'tty1' from '172.16.3.45'
Mar 15 14:01:17 LanGpsV4 login[15711]: root login on 'tty1' from '172.16.3.45'
```

With "List detailed version information" a number of version numbers (including LANTIME software, operating system and NTPD) are shown in a textbox.

The function "List LANTIME Options" shows the hardware options installed in your LANTIME.

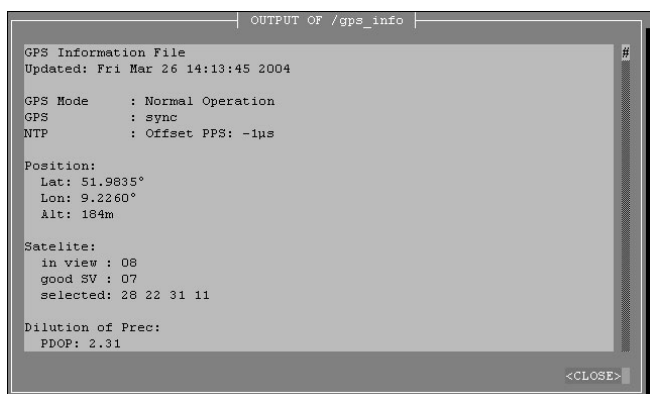

```
OUTPUT OF /gps_info
GPS Information File
Updated: Fri Mar 26 14:13:45 2004
GPS Mode : Normal Operation
GPS : sync
NTP : Offset PPS: -1ps
Position:
Lat: 51.9835°
Lon: 9.2260°
Alt: 184m
Satellite:
in view : 08
good SV : 07
selected: 28 22 31 11
Dilution of Prec:
PDOP: 2.31
<CLOSE>
```

Using the button "List detailed GPS information" gives you the possibility to check detailed GPS status information. The first parameter indicates the time and date of the last update of the shown parameters. Next you find the GPS receiver status and the NTP status, followed by the GPS position data. The position uses the Latitude / Longitude / Altitude format. Latitude and Longitude are shown in degrees, minutes and seconds, Altitude is shown in meters above WGS84 ellipsoid.

The satellite section shows the numbers of satellites in view and the number of usable satellites ("good SV"). Additionally, the selected set of the four used satellites can be read.

The accuracy of the calculated receiver position and time deviation is dependent on the constellation of the four selected satellites. Using the position of the receiver and the satellites, a number of values can be calculated, which allow a rating of the selected constellation. These values are called "Dilutions of Precision (DOP)".

PDOP is the abbreviation for "Position Dilution of Precision", TDOP means "Time Dilution of Precision" and GDOP stands for "General Dilution of Precision". Lower values are indicating better accuracy.

The next section "Satellite Info" shows information about all the satellites, which are in view momentarily. The satellite ID, elevation, Azimuth and distance to the receiver reveal the position of the satellite in the sky. The

Doppler shows whether the satellite is ascending (positive values) or descending (negative value).

Software Update

If you need to update the software of your LANTIME, you need a special file `update.tgz` from Meinberg, which has to be uploaded to the LANTIME by using ftp, SCP or SFTP to the root dir (`/update.tgz`), after the file transfer is complete, press "Start firmware update".

Afterwards you are prompted to confirm the start of the update process. The scope of the update only depends on the chosen file.

13 SNMP Support

The Simple Network Management Protocol (SNMP) has been created to achieve a standard for the management of different networks and the components of networks. SNMP is operating on the application layer and uses different transport protocols (like TCP/IP and UDP), so it is network hardware independent.

The SNMP design consists of two types of parties, the agent and the manager. SNMP is a client-server architecture, where the agent represents the server and the manager represents the client.

The LANTIME has an integrated SNMP agent, who is designed especially to handle SNMP requests for LANTIME specific status information (including status variables for the internal reference clock). The LANTIME SNMP agent is also capable of handling SET requests in order to manage the LANTIME configuration via SNMP, if your SNMP management software is also supporting this feature.

The elements (objects / variables) are organised in data structures called Management Information Base (MIB). The LANTIME includes the standard NET-SNMP MIB and is based on SNMPv1 (RFC 1155, 1157), SNMPv2 (RFC 1901-1908) and SNMPv3.

The following SNMP version is installed on the timeserver:

```

Net-SNMP Version:          5.0.8
Network transport support: Callback Unix TCP UDP TCPIPv6 UDPIPv6
SNMPv3 Security Modules:  usm
Agent MIB code:           mibII, ucd_snmp, snmpv3mibs,
                           notification, target, agent_mibs, agentx
                           agent_mibs, utilities, meinberg, mibII/ipv6
Authentication support:   MD5 SHA1
Encryption support:      DES
  
```

By using the special Meinberg SNMP-agent all important status variables can be read with SNMP conformant client software. Where applicable, a variable is implemented as string and numeric value, for example allowing SNMP client software to use the information for drawing diagrams or monitor threshold levels.

When using the NET-SNMP suite, you can read all status information your LANTIME offers via SNMP by using the `snmpwalk` command:

```
snmpwalk -v2c -c public timeserver enterprises.5597
```

```

...mbgLtNtp.mbgLtNtpCurrentState.0 = 1 : no good refclock (->local)
...mbgLtNtp.mbgLtNtpCurrentStateVal.0 = 1
...mbgLtNtp.mbgLtNtpStratum.0 = 12
...mbgLtNtp.mbgLtNtpActiveRefclockId.0 = 1
...mbgLtNtp.mbgLtNtpActiveRefclockName.0 = LOCAL(0)
...mbgLtNtp.mbgLtNtpActiveRefclockOffset.0 = 0.000 ms
...mbgLtNtp.mbgLtNtpActiveRefclockOffsetVal.0 = 0
...mbgLtNtp.mbgLtNtpNumberOfRefclocks.0 = 3
...mbgLtNtp.mbgLtNtpAuthKeyId.0 = 0
...mbgLtNtp.mbgLtNtpVersion.0 = 4.2.0@1.1161-r Fri Mar 5 15:58:56 CET 2004 (3)

...mbgLtRefclock.mbgLtRefClockType.0 = Clock Type: GPS167 1HE
...mbgLtRefclock.mbgLtRefClockTypeVal.0 = 1
...mbgLtRefclock.mbgLtRefClockMode.0 = Clock Mode: Normal Operation

...mbgLtRefclock.mbgLtRefClockModeVal.0 = 1
  
```

```
...mbgLtRefclock.mbgLtRefGpsState.0 = GPS State: sync
...mbgLtRefclock.mbgLtRefGpsStateVal.0 = 1
...mbgLtRefclock.mbgLtRefGpsPosition.0 = GPS Position: 51.9834° 9.2259° 181m
...mbgLtRefclock.mbgLtRefGpsSatellites.0 = GPS Satellites: 06/06
...mbgLtRefclock.mbgLtRefGpsSatellitesGood.0 = 6
...mbgLtRefclock.mbgLtRefGpsSatellitesInView.0 = 6
...mbgLtRefclock.mbgLtRefPzfState.0 = PZF State: N/A
...mbgLtRefclock.mbgLtRefPzfStateVal.0 = 0
...mbgLtRefclock.mbgLtRefPzfKorrelation.0 = 0
...mbgLtRefclock.mbgLtRefPzfField.0 = 0
```

Please note that you only see the object names (like "mbgLtRefclock.mbgLtRefPzfField") if you installed the Meinberg MIB files on your client workstation first (please see the web interface or CLI setup tool chapters to find out how to do this).

By using the standard MIB, no NTP get requests are allowed. Only the standard system and network parameters can be accessed (e.g. using the NET-SNMP command "snmpget").

Only by using the Meinberg MIB the change of configuration parameters is possible (the command "snmpset" is used to alter a variable, for example).

13.1 Configuration over SNMP

The LANTIME timeserver can be configured via several user interfaces. Besides the possibility to setup its parameters with the web interface (HTTP and/or HTTPS) and the direct shell access via Telnet or SSH, a SNMP based configuration interface is available.

In order to use the SNMP configuration features of the timeserver, you need to fulfil the following requirements (the system has to be reachable over the network, of course):

- a) SNMP has to be activated in the timeservers setup by setting up a RWCOMMUNITY
- b) In the SNMP configuration the read-write-access needs to be activated
- c) The timeserver-specific MIB files must be present on the clients, they have to be included in the SNMP setup of the client software

a) and b) can be achieved by using the web interface or the shell access, please see the appropriate chapters in this manual. The mentioned MIB files can be found directly on the timeserver located at /usr/local/share/snmp/mibs. All files with names starting with "MBG-SNMP-" have to be copied onto the SNMP clients by using the timeservers ftp access (for example). You may also use the web interface, on the page "Local - LANTIME Services" (V5) or "System - Services and Functions" (V6) you will find a button "Download MIB files". You will get a tar-archive if you are using the download button, which you have to unpack first.

Afterwards, copy all MIB files to the MIB directory on your client(s) and configure your SNMP client software to use them.

13.1.1 Examples for the usage of the SNMP configuration features

The following examples are using the software net-snmp, a SNMP open source project. You will find detailed information at www.net-snmp.org!

To browse the configuration branch of the timeserver-MIB, you could use the following command on a UNIX system with net-snmp SNMP tools installed:

```
root@testhost:/# snmpwalk -v 2c -c public timeserver.meinberg.de mbgLtCfg

MBG-SNMP-LANTIME-CFG-MIB::mbgLtCfghostname.0 = STRING: LantimeSNMPTest
MBG-SNMP-LANTIME-CFG-MIB::mbgLtCfgDomainname.0 = STRING: py.meinberg.de
MBG-SNMP-LANTIME-CFG-MIB::mbgLtCfgNameserver1.0 = STRING: 172.16.3.1
MBG-SNMP-LANTIME-CFG-MIB::mbgLtCfgNameserver2.0 = STRING:
MBG-SNMP-LANTIME-CFG-MIB::mbgLtCfgSyslogserver1.0 = STRING:
MBG-SNMP-LANTIME-CFG-MIB::mbgLtCfgSyslogserver2.0 = STRING:
[ ... ]
```

To alter a parameter, with net-snmp you would use the snmpset command:

```
root@testhost:/# snmpset -v 2c -r 0 -t 10 -c rwsecret timeserver.meinberg.de
mbgLtCfghostname.0 string „helloworld“

MBG-SNMP-LANTIME-CFG-MIB::mbgLtCfghostname.0 = STRING: helloworld
root@testhost:/#
```

Please note that your SNMP request has to be sent with a sufficient timeout (in the above snmpset example this was achieved by using the “-t 10” option, choosing a timeout of 10 seconds), because after each parameter change, the timeserver reloads its configuration, which takes a few seconds. The request is acknowledged by the SNMP agent afterwards.

To change a group of parameters without reloading the configuration after each parameter, you have to send all parameter changes in one single request. You can do this with the net-snmp snmpset command by specifying multiple parameters in one command line:

```
root@testhost:/# snmpset -v 2c -r 0 -t 10 -c rwsecret timeserver.meinberg.de
mbgLtCfghostname.0 string „helloworld“ mbgLtCfgDomainname.0 string
„internal.meinberg.de“

MBG-SNMP-LANTIME-CFG-MIB::mbgLtCfghostname.0 = STRING: helloworld
MBG-SNMP-LANTIME-CFG-MIB::mbgLtCfgDomainname.0 = STRING: internal.meinberg.de

root@testhost:/#
```

The available SNMP variables are described in detail in the “SNMP configuration reference” part of this manual. Additionally, it is recommended to also read the mentioned MIB files.

13.1.2 Further configuration possibilities

Because the timeserver uses a standard version of the net-snmp SNMP daemon (with extended features covering the timeserver-specific functions), all configuration parameters of the SNMPD can be used. The configuration file of the SNMP daemon is located at `/usr/local/share/snmp` after boot time, the filename is `snmpd.conf`.

During the boot sequence, this file is created dynamically by using a template file and appending the SNMP parameters stored in the timeserver setup.

If you need to customize the configuration of the timeservers SNMPD (for setting up detailed access control rights for example), you may edit `/mnt/flash/packages/snmp/etc/snmpd_conf.default` (which is the mentioned template file). Please note that some lines are appended to this file (as described above), before it is used as `/usr/local/share/snmp/snmpd.conf` by the `snmpd` process.

13.1.3 Send special timeserver commands with SNMP

The timeserver is capable of receiving special commands by SNMP in order to reboot the unit or reload its configuration after you manually changed it. A special SNMP variable is reserved for this (`mbgLtCmdExecute`) and has to be set to a special integer value for each command. The following commands are available:

Reboot(1)

Setting the `mbgLtCmdExecute` variable to value 1 will reboot the timeserver after a short waiting period of approximately 3-5 seconds.

FirmwareUpdate(2)

This command installs a previously uploaded (with FTP for example) firmware version.

ReloadConfig(3)

The parameters of the timeserver configuration (stored in `/mnt/flash/global_configuration`) are re-read and afterwards a number of subsystems (e.g. NTPD, HTTPD/HTTPS, SMBD) will be restarted in order to use those eventually changed settings. Please note that the SNMPD will not be restarted by this command (you have to use `reboot` instead or restart it manually by killing the process and starting it again in the shell).

GenerateSSHKey(4)

A new SSH key will be generated.

GenerateHTTPSKey(5)

A new HTTPS key will be generated.

ResetFactoryDefaults(6)

The configuration of the timeserver is reset to factory defaults, afterwards an automatic `ReloadConfig` is executed in order to use these default settings.

GenerateNewNTPAutokeyCert(7)

A new key is generated, it can be used with the NTP AUTOKEY feature.

SendTestNotification(8)

A test message is sent by using all notification methods the timeserver has a configuration for (e.g. mail, win-popup, SYSLOG etc.).

A few examples:

(we are again using the `snmpset` command which comes with the `net-snmp` tools).

```
root@testhost:/# snmpset -v2c -r 0 -t 10 -c rwsecret timeserver.meinberg.de
mbgLtCmdExecute.0 int 1
```

```
MBG-SNMP-LANTIME-CMD-MIB::mbgLtCmdExecute.0 = INTEGER: Reboot(1)
root@testhost:/#
```

The command shown above is forcing the timeserver to reboot. Instead of using the integer value, you may also enter the command name, as it is defined in the MIB file MBG-SNMP-LANTIME-CMD.txt (and in the command list above).

If you want the timeserver to reload it's configuration file (which you previously uploaded via FTP probably), you would enter this command:

```
root@testhost:/# snmpset -v2c -r 0 -t 10 -c rwsecret timeserver.meinberg.de  
mbgLtCmdExecute.0 int ReloadConfig
```

```
MBG-SNMP-LANTIME-CMD-MIB::mbgLtCmdExecute.0 = INTEGER: ReloadConfig(3)
```

```
root@testhost:/#
```

Please pay attention to the options “-r 0” (meaning “no retries”) and “-t 10” (meaning “timeout of 10 secs”) in the above examples. These options avoid multiple executions of the desired command, additionally they give your snmpset command enough time to wait for an acknowledgement from the timeservers snmp agent.

13.1.4 Configuration of the timeserver with SNMP: Reference

The MIB of the timeserver includes the following parts:

SNMP Object	Name	Description
enterprises.5597	mbgSNMP	Root node of the Meinberg-MIB
mbgSNMP.3	MbgLANTIME	Root node of the LANTIME MIB
mbgLANTIME.1	mbgLtNtp	LANTIME NTP status variables
mbgLANTIME.2	mbgLtRefclock	LANTIME reference time source status variables
mbgLANTIME.3	mbgLtTraps	LANTIME SNMP traps
mbgLANTIME.4	mbgLtCfg	LANTIME configuration variables
mbgLANTIME.5	mbgLtCmd	LANTIME control commands

Further detailed information can be found in the Meinberg MIB files.

Reference of LANTIME SNMP configuration variables:

SNMP branch	Variable	Data type	Description
mbgLtCfgNetwork	mbgLtCfghostname	string	The hostname of the timeserver
	mbgLtCfgDomainname	string	The Domainname of the timeserver
	mbgLtCfgNameserver1	string (IPv4 or IPv6-address)	IP-address of first nameserver
	mbgLtCfgNameserver2	string (IPv4 or IPv6-address)	IP-address of second nameserver
	mbgLtCfgSyslogserver1	string (IPv4 or IPv6-address or hostname)	IP-address or hostname of first syslog-server
	mbgLtCfgSyslogserver2	string (IPv4 or IPv6-address or hostname)	IP-address or hostname of second syslog-server
	mbgLtCfgTelnetAccess	integer (0 = disabled, 1 = enabled)	Telnet access activated?
	mbgLtCfgFTPAccess	integer (0 = disabled, 1 = enabled)	FTP-access activated?
	mbgLtCfgHTTPAccess	integer (0 = disabled, 1 = enabled)	Webinterface activated?
	mbgLtCfgHTTPSAccess	integer (0 = disabled, 1 = enabled)	Encrypted webinterface activated?
mbgLtCfgSNMPAccess	integer (0 = disabled, 1 = enabled)	SNMP-daemon activated?	

SNMP branch	Variable	Data type	Description
	mbgLtCfgSambaAccess	integer (0 = disabled, 1 = enabled)	LANManager-access activated?
	mbgLtCfgIPv6Access	integer (0 = disabled, 1 = enabled)	IPv6-protocol enabled?
	mbgLtCfgSSHAccess	integer (0 = disabled, 1 = enabled)	SSH-access activated?
mbgLtCfgNTP	mbgLtCfgNtpServer1IP	string (IPv4 or IPv6-address or hostname)	First external NTP-server
	mbgLtCfgNtpServer1KEY	integer	Link to the key which should be used for the first NTP-server
	mbgLtCfgNtpServer2IP	string (IPv4 or IPv6-address or hostname)	Second external NTP-server
	mbgLtCfgNtpServer2KEY	integer	Link to the key which should be used for the second NTP-server
	mbgLtCfgNtpServer3IP	string (IPv4 or IPv6-address or hostname)	Third external NTP-server
	mbgLtCfgNtpServer3KEY	integer	Link to the key which should be used for the third NTP-server
	mbgLtCfgStratumLocal Clock	integer(0..15)	Stratum-value of the internal system clock of the timeserver
	mbgLtCfgNTPTrustedKey	integer	Link to the key which should be used for the internal reference time source
	mbgLtCfgNTPBroadcastIP	string (IPv4 or IPv6-address)	IP-address, which has to be used for NTP-broadcasts (or multicasts)
	mbgLtCfgNTPBroadcast Key	integer	Link to the key which should be used for outgoing NTP-broadcasts
	mbgLtCfgNTPBroadcast Autokey	integer (0 = disabled, 1 = enabled)	Use autokey for NTP broadcasts?
	mbgLtCfgAutokeyFeature	integer (0 = disabled, 1 = enabled)	Use autokey feature of the NTP server?

SNMP branch	Variable	Data type	Description
	mbgLtCfgAtomPPS	integer (0 = disabled, 1 = enabled)	Atom PPS (pulse per second) activated?
mbgLtCfgEMail	mbgLtCfgEMailTo	string (Liste von EMail-addressn)	One or more (semicolon separated) email address(es). which should receive warnings and alarm notifications from the timeserver
	mbgLtCfgEMailFrom	string (EMail-address)	The EMail-address which is used as the senders address for email notifications
	mbgLtCfgEMailSmarthost	string (IPv4 or IPv6-address or hostname)	The SMTP-host, which is used for sending mails
mbgLtCfgSNMP	mbgLtCfgSNMPTrapReceiver1	string (IPv4 or IPv6-address or hostname)	First host, which receives notifications sent as SMTP-traps
	mbgLtCfgSNMPTrapReceiver1Community	string	The SNMP community used when sending SNMP-Traps to the first host
	mbgLtCfgSNMPTrapReceiver2	string (IPv4 or IPv6-address or hostname)	Second host, which receives notifications sent as SMTP-traps
	mbgLtCfgSNMPTrapReceiver2Community	string	The SNMP community used when sending SNMP-Traps to the second host
	mbgLtCfgSNMPROCommunity	string	The SNMP community, which has read-only access and therefore can be used to only monitor status variables or configuration values (SNMP V2c)
	mbgLtCfgSNMPRWCommunity	string	The SNMP community, which has read-write access and there for can be used to monitor status variables and get/set configuration values (SNMP V2c)
	mbgLtCfgSNMPContact	string	Contact information (e.g. name of a contact person) of the timeserver
	mbgLtCfgSNMPLocation	string	Location (e.g. building/room number) of the timeserver
mbgLtCfgWinpopup	mbgLtCfgWMailAddress1	string	First receiver of notifications sent as windows popup messages
	mbgLtCfgWMailAddress2	string	Second receiver of notifications sent as windows popup messages

SNMP branch	Variable	Data type	Description
mbgLtCfgWalldisplay	mbgLtCfgVP100Display1IP	string (IPv4 or IPv6-address or hostname)	hostname or IP-address of the first wall-mount display used for showing notifications
	mbgLtCfgVP100Display1SN	string (Hexstring)	The serial number of the first wall mount display used for showing notifications (can be found in the setup menu of the display)
	mbgLtCfgVP100Display2IP	string (IPv4 or IPv6-address or hostname)	hostname or IP-address of the second wall mount display used for showing notifications
	mbgLtCfgVP100Display2SN	string (Hexstring)	The serial number of the first wall mount display used for showing notifications (can be found in the setup menu of the display)
mbgLtCfgNotify	mbgLtCfgNotifyNTPNotSync	string(combination)	Exactly one, none or a combination of the following notification types: email = sending an email wmail = sending a winpopup-message snmp = sending a SNMP-trap, disp = showing on wall mount display, syslog = sending a syslog-entry for the event „NTP not synchronized“
	mbgLtCfgNotifyNTPStopped	string (combination)	(see mbgLtCfgNotifyNTPNotSync) for the event „NTP Daemon stopped“
	mbgLtCfgNotifyServerBoot	string (combination)	(see mbgLtCfgNotifyNTPNotSync) for the event „Timeserver reboot“
	mbgLtCfgNotifyRefclockNotResponding	string (combination)	(see mbgLtCfgNotifyNTPNotSync) for the event „Refclock not ready“
	mbgLtCfgNotifyRefclockNotSync	string (combination)	(see mbgLtCfgNotifyNTPNotSync) for the event „Refclock not synchron“
	mbgLtCfgNotifyAntennaFaulty	string (combination)	(see mbgLtCfgNotifyNTPNotSync) for the event „GPS antenna not connected or damaged“
	mbgLtCfgNotifyAntennaReconnect	string (combination)	(see mbgLtCfgNotifyNTPNotSync) for the event „GPS antenna reconnected“
	mbgLtCfgNotifyConfigChanged	string (combination)	(see mbgLtCfgNotifyNTPNotSync) for the event „Configuration changed“
	mbgLtCfgNotifyLeapSecondAnnounced	string (combination)	(see mbgLtCfgNotifyNTPNotSync) for the event „Leap second announced“

SNMP branch	Variable	Data type	Description
mbgLtCfgEthernet	mbgLtCfgEthernetIf0IPv4 IP	string (IPv4 IP-address)	IPv4-address of first network interface of the timeserver
	mbgLtCfgEthernetIf0IPv4 Netmask	string (IPv4 Netzmaske)	IPv4-netmask of first network interface of the timeserver
	mbgLtCfgEthernetIf0IPv4 Gateway	string (IPv4 IP-address)	IPv4-address of the default gateway of the timeservers first network interface
	mbgLtCfgEthernetIf0DHCP Client	integer (0 = disabled, 1 = enabled)	Configure the first network interface of the timeserver with DHCP?
	mbgLtCfgEthernetIf0IPv6 IP1	string (IPv6 IP-address)	First IPv6-IP-address of the timeservers first network interface
	mbgLtCfgEthernetIf0IPv6 IP2	string (IPv6 IP-address)	Second IPv6-IP-address of the timeservers first network interface
	mbgLtCfgEthernetIf0IPv6 IP3	string (IPv6 IP-address)	Third IPv6-IP-address of the timeservers first network interface
	mbgLtCfgEthernetIf0IPv6 Autoconf	integer (0 = disabled, 1 = enabled)	Activate autoconf for the IPv6 - configuration of the timeservers first network interface?
mbgLtCfgEthernetIf0 NetlinkMode	integer (0..4)	Configuration of the network-speed and duplex settings of the timeservers first network interface 0 = autosensing, 1 = 10Mbit/s half duplex, 2 = 10Mbit/s full duplex, 3 = 100Mbit/s half duplex, 4 = 100Mbit/s full duplex	

For all additional Ethernet interfaces of the timeserver, "If0" only has to be replaced with "Ifx", where "x" is substituted by the number of the desired Ethernet interface. Example: The IPv4-address of the timeservers third Ethernet interface can be set with mbgLtCfgEthernetIf2IPv4IP!

13.2 SNMP Traps

If configured, the LANTIME is sending SNMP traps, which can be received by up to 2 SNMP management systems. These traps can be received by using the NET-SNMP suite tool "snmptrapd", you can start it on a UNIX system with "snmptrapd -p" (-p is for output to stdout, -s would use the syslog for output). The corresponding MIB files can be found on the LANTIME at /usr/local/share/snmp/mibs/, all Meinberg specific MIB files are named "MBG-SNMP..." . These MIB files can be downloaded by using the web interface (see "Local" page, "Download MIB files" button), after unpacking the archive file you can import the MIB files into your management system.

The following SNMP-traps are available:

"NTP not sync"	NTP not synchronised to refclock
"NTP stopped"	NTP stopped
"Server boot"	System has rebooted
"Receiver not responding"	no answer from GPS
"Receiver not sync"	GPS receiver not synchronised
"Antenna faulty"	GPS antenna not connected
"Antenna reconnect"	GPS antenna reconnected
"Config changed"	System parameter changed by user
„Leap second announced“	Leap second announced

See the "Notification" page at the web interface and Command Line Interface description to learn how to configure the SNMP trap receivers.

13.2.1 SNMP Trap Reference

All traps can be found under the mbgLtTraps section in the Meinberg MIB. A special trap exists for every notification event the timeserver knows. Please note that the traps are only sent if you configured the notification type "SNMP trap" for the event, otherwise no trap is generated. All traps have a string parameter included, which contains the plain text event message for the appropriate event (you are able to change the default text messages, see web interface and/or CLI setup section to find out how to do this).

Here is a list of all traps the timeserver knows:

- **mbgLtTrapNTPNotSync (mbgLtTraps.1):** Whenever the NTP daemon (ntpd) loses sync, it will generate this trap and send it to the configured SNMP trap receivers.
- **mbgLtTrapNTPStopped (mbgLtTraps.2):** This trap is sent when the NTP daemon stopped, manually or because of an error condition.
- **mbgLtTrapServerBoot (mbgLtTraps.3):** After finishing the boot process, this trap is generated.
- **mbgLtTrapReceiverNotResponding (mbgLtTraps.4):** Trap to be sent when the internal receiver of the timeserver is not responding.
- **mbgLtTrapReceiverNotSync (mbgLtTraps.5):** If the internal receiver loses sync, the SNMP trap receivers will receive this trap.
- **mbgLtTrapAntennaFaulty (mbgLtTraps.6):** This trap will be sent whenever the timeserver recognises a broken connection to the antenna of the receiver.
- **mbgLtTrapAntennaReconnect (mbgLtTraps.7):** After the connection to the antenna has been re-established, this trap is sent.
- **mbgLtTrapConfigChanged (mbgLtTraps 8):** After reloading its configuration, the timeserver generates this trap.
- **mbgLtTrapLeapSecondAnnounced (mbgLtTraps 9):** If a leap second has been announced by the internal GPS receiver, this trap will be sent.
- **mbgLtTrapTestNotification (mbgLtTraps 99):** This trap is sent whenever you are requesting a test notification; it is only used for testing the connection between the timeserver and your SNMP trap receivers.

14 Attachment: Technical Information

14.1 Skilled/Service-Personnel only: Replacing the Lithium Battery

The life time of the lithium battery on the board is at least 10 years. If the need arises to replace the battery, the following should be noted:

ATTENTION!

There is a Danger of explosion if the lithium battery is replaced incorrectly. Only identical batteries or batteries recommended by the manufacturer must be used for replacement.



The waste battery has to be disposed as proposed by the manufacturer of the battery.

CE marking

This device follows the provisions of the directives 93/68/EEC



14.2 Technical Specifications M200 Slimline Desktop

HOUSING:	Metal slimline desktop case M200 1U
PROTECTION RATING:	IP20
OPERATION VOLTAGE:	100-240V AC (50/60Hz) optional available DC variants: 100-240V DC, 12, 24 and 48V DC
POWER CONSUMPTION:	20W
PHYSICAL DIMENSIONS:	335 mm wide x 45 mm high x 240 mm deep

14.3 Safety instructions for building-in equipment

This building-in equipment has been designed and tested in accordance with the requirements of Standard IEC60950-1 "Safety of Information Technology Equipment, including Electrical Business Equipment".

During installation of the building-in equipment in an end application (i.e. rack) additional requirements in accordance with Standard IEC60950-1 have to be taken into account.

- The building-in equipment is a class 1 - equipment and must be connected to an earthed outlet (TN Power System).
- The building-in equipment has been evaluated for use in office environment (pollution degree 2) and may be only used in this environment. For use in rooms with a higher pollution degree more stringent requirements are applicable.
- The building-in equipment may not be opened.
- Protection against fire must be assured in the end application.
- The ventilation opening may not be covered.
- The equipment/building-in equipment was evaluated for use in a maximum ambient temperature of 40°C.
- For safe operation the building-in equipment must be protected by max 16 A fuse in the power installation system.
- Disconnection of the equipment from mains is done by pulling the mains plug.

14.3.1 CE-Label

Low voltage directive:

2006/95/EC EN 60950-1
Safety of Information Technology Equipment,
including Electrical Business Equipment
Electromagnetic compatibility.

EMV-directive:

89/336EEC EN50081-1
Electromagnetic compatibility (EMC).
Generic emission standard.
Part 1: Residential, commercial and light industry

EN50082-2
Electromagnetic compatibility (EMC).
Generic immunity standard.
Part 2: Industrial environment



14.4 Rear Panel Connectors

Name	Type	Signal	Cable
Network	RJ-45	Ethernet	shielded data line
Antenna	N-Norm BNC	WWVB	shielded coaxial line
Power supply	power cord receptable		power supply cord
Terminal	D-SUB9	RS232	Serial Cable (Null Modem)
USB	USB	USB 1.1 USB Storage Devices	For connection

14.5 TERMINAL (Console)

To connect a serial terminal use 9 pin SUBD RS232 connector in the front panel. Via the serial terminal connection it is possible to configure parameters with the command line interface. You have to use a NULL-MODEM cable connecting to your PC or Laptop computer. You can use e.g. the standard Hyperterminal program shipped with your Windows operating system. Configure your terminal program with 38400 Baud, 8 Databits, no parity and 1 Stopbit. The terminal emulation have to set to VT100. After connecting to the timeserver there will be displayed the login message (press RETURN for first connection; default user: root password: timeserver).

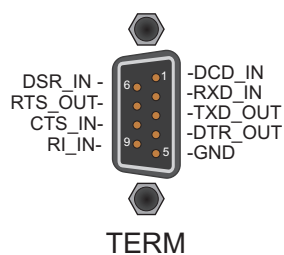

14.6 Technical specifications WWVB5xx

RECEIVER:	Direct conversion quadrature receiver with automatic gain control Bandwidth: approx. 20Hz, external ferrite antenna
CONTROL OF RECEPTION:	The WWVB-signal is checked for minimum field strength by microprocessor. The result is indicated by LED. In addition, the value of the digitized field strength is displayed in menu 'FIELD'.
BACKUP:	In case of supply voltage failure the on-board RTC keeps the time based on XTAL for more than 150 hours (buffer capacitor) optional lithium backup battery (life time: 10 years)
DISPLAY:	Eight-digit alphanumeric display shows important time and status information. Digit-height 5mm.
INTERFACES:	Three independent RS232 ports Baudrate: 600, 1200, 2400, 4800, 9600 or 19200 Baud Framing: 7N2, 7E1, 7E2, 8N1, 8N2, 8E1, 7O2 or 8O1 Time string: Meinberg Standard
PULSE OUTPUTS:	Active-high and active-low pulses per minute and per second, TTL-level, pulse duration 200ms
TIME_SYN OUTPUT:	TTL-level, logical-high if receiver is synchronous
TERMINAL CONNECTION:	Blade-connector strip VG64, DIN 41612 Sub-miniature coaxial HF-connector (SMB)
BOARD DIMENSIONS:	Eurocard size 100mm x 160mm, Epoxy 1,5mm Front panel 12TE (61mm)
ANTENNA:	Ferrite antenna in plastic housing (AW02-60)
HUMIDITY:	Relative humidity 85% max.
TEMPERATURE RANGE:	0 ... 50°C
POWER SUPPLY:	+ 5V, 230mA

14.7 Technical Specifications LAN CPU

PROCESSOR:	Geode™ LX800 with 500 MHz
MAIN MEMORY:	256 MB
CACHE-MEMORY:	16 KB 2nd Level Cache
FLASHDISK:	64 MB (128 MB)
NETWORK CONNECTOR:	10/100 MBIT with RJ45-Jack DAVICOM DM9102AEthernet NIC Controller
SERIAL - INTERFACE:	Four serial RS232-Ports 16550 compatible to FIFO <ul style="list-style-type: none">- RS232 9-pol. DSUB-male connector- three RS232 male connector according to DIN 41612, type C 96 (only TxD, RxD, DCD)
PARALLEL INTERFACE :	One LPT-Port male connector type C 96
VGA-CONNECTION:	10-pol pin contact strip
KEYBOARD CONNECTION:	10-pol pin contact strip
STATE LEDs:	- power supply - 'Connect', 'Activity' and 'Speed' of the network connection
POWER REQUIREMENTS:	5 V +- 5 %, @ 1 A
FRONTPANEL:	3 HE / 4 TE (128 mm high x 20,3 mm wide)
CONNECTOR:	According to DIN 41612, type C 96, rows a+b+c (male) DSUB-plug (9-pol) RJ45-jack
AMBIENT TEMPERATURE:	0 ... 50 °C
HUMIDITY:	85 % max.

14.7.1 Rear Connector Pin Assignments LAN CPU

	c	b	a	
1	VCC in (+5V)	VCC in (+5V)	VCC in (+5V)	
2	VCC in (+5V)	VCC in (+5V)	VCC in (+5V)	
3	GND	GND	GND	
4	PPS in	/AFD out	/STB out	
5	/ERR in	/SLIN out	/INIT out	
6	D5 in/out	D6 in/out	D7 in/out	LPT1
7	D2 in/out	D3 in/out	D4 in/out	
8	/ACK in	D0 in/out	D1 in/out	
9	/SLCT in	PE in	/BUSY in	
10	GND	GND	GND	
11	GND	GND	GND	
12	DIAG_S in/out	/CS1 out	/CS3 out	
13	A0 out	A1 out	A2 out	
14	RDY in	/AK out	INTRQ in	
15	DRQ in	/IOW out	/IOR out	
16	D15 in/out	D0 in/out	D14 in/out	Primary IDE
17	D1 in/out	D13 in/out	D2 in/out	
18	D12 in/out	D3 in/out	D11 in/out	
19	D4 in/out	D10 in/out	D5 in/out	
20		D9 in/out	D7 in/out	
21	D6 in/out	D8 in/out	/HDRST out	
22	GND	GND	GND	
23	Rx+ in	Tx- out	Tx+ out	
24	Rx- in	LED LINK out	LED ACTIVITY out	Ethernet
25		LED SPEED 100M out	LED SPEED10M out	
26	GND	GND	GND	
27	RxD4 in	TxD4 out	DCD4 in	
28	RxD3 in	TxD3 out	DCD3 in	RS232
29	RxD2 in	TxD2 out		
30	RxD1 in	TxD1 out	DCD1 in	
31	GND	GND	GND	
32	GND	GND	GND	

14.7.2 VGA, Keyboard Connector Pin Assignments

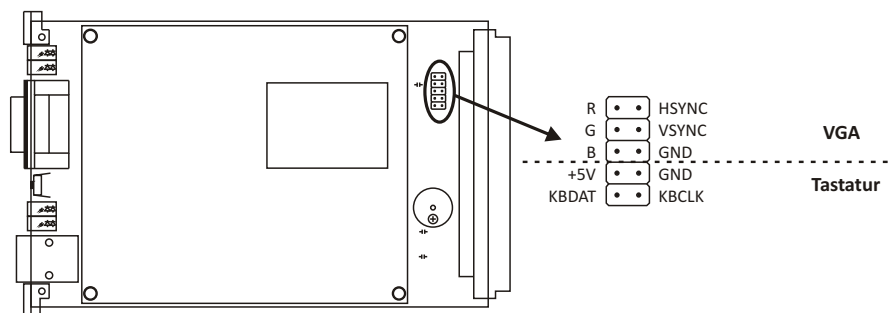

14.8 Manual VP100/NET Display configuration

send2display Version 0.1

usage: send2display -h hostname -s serialnumber [options]

Valid options are:

-h,	-host H	Uses H as the hostname of the display unit
-s,	-serialnumber S	Uses S as the serialnumber of the display (e.g. 03A00C7F)
-c,	-clear M	Clear message M (0-31)
-b,	-beep	Beeper sound while showing the message
-a,	-clearall	Clear all messages of the display
-m,	-message M	Create/change message M (0-31, default = 0)
-e,	-executions E	Sets number of consecutive executions to E (1-9, default = 1)
-q,	-quiet	Quiet mode (no program output to stdout/stderr)
-v,	-verbose	Verbose mode (output of debugging info on stdout)
-?,	-help	Show help message

Defining messages

a) Static or flashing text:

You can define a maximum of 9 lines for a message.

Start with -(x) "text", where (x) represents the line number.

-1,	-line1 "text"	Set text for line 1
-2,	-line2 "text"	Set text for line 2
...		

You can set the duration and mode for each line separately. Specify the following options directly after the text-definition of a line:

-f,	-noflash	Change line mode to static (default is flashing)
-d,	-duration X	Set the duration of the line to x seconds (default is 3 seconds)

b) Scrolling text:

You can define a maximum of 241 characters per scrolling message. If you want the message to "softly" end, simply add some spaces to the end of your text (attention: text and spaces must be no more than 241 chars in length).

-t,	-scrolltext "text"	Set scrolltext
-----	--------------------	----------------

If you want the message (any type) to appear periodically, you can set the time interval with:

-D,	-periodday D	Display message every D days
-H,	-periodhour H	Display message every H hours
-M,	-periodminute M	Display message every M minutes

(You can combine these options. Default is: message is displayed only once)

Possible error codes: 1=parameter error, 2=no ACK from display, 3=network error

Examples:

```
send2display -h 172.16.3.251 -s 0a03007f -m1 -e2 -1 "Hello World" -d5 -2 "what a nice day" -d3
(shows two lines of text (2 times), 1st line is shown for 5 seconds and 2nd line for 3 seconds)
```

```
send2display -h 172.16.3.251 -s 0a03007f -m1 -e1 -1 "Oops" -H2 -M30
(shows one line of text every 2 hours and 30 minutes, a sound (beep)
can be heard while the message is displayed)
```

```
send2display -h 172.16.3.251 -s 0a03007f -c1
```

(deletes the message 1, so no more beeps every 2:30 hrs ...)

```
send2display -h 172.16.3.251 -s 0a03007f -t"Hello world..." -e3
```

(shows a scrolling message with soft end, repeating it 3 times)

14.9 Global Configuration File

This file contains all global parameters of the LANTIME. You can find this file on the write protected flash disk at /mnt/flash/global_configuration:

```
#-----#
#--- Configuration File ---#
#-----#

# Configuration File Section
Configuration File Version Number:      4.17
Configuration File Last Change:

# Network Parameter Section
Hostname                                [ASCII,50] : LanGpsV4
Domainname                              [ASCII,50] : py.meinberg.de
Default IPv4 Gateway                     [IP]       :
Default IPv6 Gateway                     [IP]       :
Nameserver 1                             [IP]       :
Nameserver 2                             [IP]       :
Syslogserver 1                           [ASCII,50] :
Syslogserver 2                           [ASCII,50] :
Telnet Port active                       [BOOL]     : 1
FTP Port active                           [BOOL]     : 1
SSH active                               [BOOL]     : 1
HTTP active                              [BOOL]     : 1
HTTPS active                             [BOOL]     : 1
SNMP active                              [BOOL]     : 1
SAMBA active                             [BOOL]     : 0
IPv6 active                              [BOOL]     : 1

# NTP Section
External NTP Server 1 IP                 [ASCII,50] :
External NTP Server 1 KEY                [NUM]      :
External NTP Server 1 AUTOKEY            [BOOL]     :
External NTP Server 2 IP                 [ASCII,50] :
External NTP Server 2 KEY                [NUM]      :
External NTP Server 2 AUTOKEY            [BOOL]     :
External NTP Server 3 IP [ASCII,50]      :
External NTP Server 3 KEY                [NUM]      :
External NTP Server 3 AUTOKEY            [BOOL]     :
NTP Stratum Local Clock                  [NUM,0..15] : 12
NTP Trusted Key                          [NUM]      :
NTP AUTOKEY feature active               [BOOL]     : 0
NTP ATOM PPS active                      [BOOL]     : 1
NTP Broadcast TCPIP                      [IP]       : 0
NTP Broadcast KEY                        [NUM]      : 0
NTP Broadcast AUTOKEY                    [BOOL]     :
NTP Trust Time                           [NUM]      : 0

# EMail Section
EMail To Address                         [ASCII,50] :
EMail From Address                       [ASCII,50] :
EMail Smarthost                          [ASCII,50] :

# SNMP Section
SNMP Trap Receiver Address 1             [ASCII,50] :
SNMP Trap Receiver Community 1           [ASCII,50] :
SNMP Trap Receiver Address 2             [ASCII,50] :
SNMP Trap Receiver Community 2           [ASCII,50] :
```

```

SNMP V3 User Name           [ASCII,50] : root
SNMP Read Community String  [ASCII,50] : public
SNMP Write Community String [ASCII,50] :
SNMP Contact String        [ASCII,50] : Meinberg
SNMP Location String       [ASCII,50] : Germany

# Windows Messages Section
WMail Address 1            [ASCII,50] :
WMail Address 2            [ASCII,50] :

# VP100 Display Section
VP100 Display Address 1    [ASCII,50] :
VP100 Display Sernum 1     [ASCII,50] :
VP100 Display Address 2    [ASCII,50] :
VP100 Display Sernum 2     [ASCII,50] :

# Notification Section
Notification on NTP_not_sync [CASE]      :
Notification on NTP_stopped  [CASE]      :
Notification on Server_boot  [CASE]      :
Notification on Refclock_not_respon. [CASE]      :
Notification on Refclock_not_sync [CASE]      :
Notification on Antenna_faulty [CASE]      :
Notification on Antenna_reconnect [CASE]      :
Notification on Config_changed [CASE]      :
Notification on Leap second announ. [CASE]      :

# Ethernet Parameter Section
ETH0 IPv4 TCPIP address     [IP]        : 0
ETH0 IPv4 NETMASK           [IP]        : 0
ETH0 DHCP CLIENT            [BOOL]       : 1
ETH0 IPv6 TCPIP address 1    [IP]        :
ETH0 IPv6 TCPIP address 2    [IP]        :
ETH0 IPv6 TCPIP address 3    [IP]        :
ETH0 IPv6 Autoconf          [BOOL]       : 1
ETH0 Net Link Mode          [NUM,0:4]    :
ETH0 Bonding Group          [NUM,0:4]    :

```

14.10 Global Option File

This file contains all global options for special hardware configuration of the LANTIME. Do not modify this file. You can find this file on the write protected flash disk at /mnt/flash/global_options:

```
#GLOBAL OPTIONS
```

```
NUMBER ETHERNET INTERFACES : 1
SYSTEM LAYOUT               : 0
SYSTEM ADV LAYOUT           : 0
SYSTEM LANGUAGE              : 0
SYSTEM PARAMETER             : server
SYSTEM DESIGN                : 0
```

14.11 USB Stick

Most LANTIME M-Series products come with a USB interface for connecting a USB storage device, e.g. a USB stick. This USB stick can be used for different tasks in combination with the LANTIME:

- Transfer configuration parameters between different LANTIMEs
- Keypad locking for secure using the keypad of the LCD
- Transfer of log files
- Install Software Updates
- Upload and download secure certificates (SSL, SSH) and passwords



When connecting the USB stick the LC Display will – after a few seconds – signal that the USB stick has been detected and allows you to enter the USB menu with the „OK“ button.

USB Memory Stick Main Menu

The desired menu function can be chosen by using ↑ and ↓ keys and it will be activated with the „OK“ button.

14.11.1 Menu Structure

If a special menu and file structure exists on the USB stick you will see these customized submenus.

The submenus with the corresponding commands have to be declared in special files on the USB stick. These files will be loaded and interpreted by the LANTIME. So it is possible to build up your own configuration. The following directory and file structure have to be placed on the USB stick:

```
/Lantime/
  Menu/
    menu_1
    script_for_menu_1
    menu_2
    script_for_menu_2
```

14.11.2 Menu Configuration Files

Every submenu will be defined by a special formatted text file. The name of this file has to be started with „menu_“. This file is an ASCII file which can be created by a standard text editor with the following format:

```
# Comment
Menu-Name: get configuration from USB Stick
Menu-Type: default
Menu-Script: get_config_from_usb_stick
Menu-Pre-Cmd:
Menu-Post-Cmd:
```

With the key name „Menu-Name:“ the text in the LC display will be defined. The „Menu-Type:“ will be always „default“ (not supported yet). The „Menu-Script“ will define the real name of the script file which will be

started if the submenu will be activated with the CLR/ACK button. The following message will be displayed on the LCD:

```
USB Stick Menu (OK to confirm)
Backup Config. to USB Stick
```

With the key names „Menu-Pre-Cmd:“ and „Menu-Post-Cmd:“ some special internal commands can be activated before or after starting the script file. The following commands are possible:

RELOAD_CONFIG: reload configuration file of the LANTIME
REBOOT: reboot the operating system on LANTIME

When connecting the USB stick to LANTIME the filesystem of the USB stick will be mounted to „/mnt/usb_storage“. This interface can be used to configure the menu and script files.

14.11.3 Menu Script Files

The name of the script file which will be activated when pressing the CLR/ACK button on a submenu will be defined in the Menu configuration file. The script files consists of commands using in a Telnet session (like „cp“ or „rm“). The following example will copy the LANTIME configuration file from the USB stick to the internal flash of the LANTIME.

```
mount -o remount, rw /mnt/flash
cp /mnt/flash/config/global_configuration /mnt/flash/config/global_configuration.old
cp /mnt/usb_storage/my_config /mnt/flash/config/global_configuration
mount -o remount, ro /mnt/flash
```

Be aware that the internal flash of the LANTIME is read only mounted. If you want to copy files to the internal flash of the LANTIME the internal flash have to be remounted for writing (use the command: „mount -o remount, rw /mnt/flash“).

14.11.4 Keypad locking

The USB stick can be used for locking the buttons of the LANTIME LC display. Activating this feature the user cannot use the buttons without connecting the USB stick to LANTIME. The access authorisation has been realized with a password file on the USB stick „/mnt/usb_storage/Lantime/keypad_lock“. This password file will be compared with „/mnt/flash/config/keypad_lock“. So it is possible to manage different LANTIME with one USB stick.

The keypad locking will be activated with a submenu from the USB stick:

```
USB Stick Menu (OK to confirm)
Lock Front Panel
```

When activating this submenu the file „/mnt/usb_storage/Lantime/keypad_lock“ will be copied to the internal flash. When de-activating the keypad locking this file will be removed from the internal flash.

```
USB Stick Menu (OK to confirm)
Unlock Front Panel
```

14.12 Third party software

The LANTIME network timeserver is running a number of software products created and/or maintained by open source projects. A lot of people contributed to this and we explicitly want to thank everyone involved for her/his great work.

The used open source software comes with its own license which we want to mention below. If one of the licenses for a third party software product is violated, we will as soon as possible apply any changes needed in order to conform with the corresponding license after we acknowledged about that violation.

If a license for one of the software products states that we have to provide you with a copy of the source code or other material, we will gladly send it to you on data media via normal post or by e-mail upon request. Alternatively we can provide you with a link to a download location in the internet, allowing you to download the most actual version. Please note that we have to charge you for any incurred expenses if you choose to receive the source code on data media.

14.12.1 Operating System GNU/Linux

The distribution of the GNU/Linux operating system is covered by the GNU General Public License (GPL), which we included below.

More information about GNU/Linux can be found on the GNU website
www.gnu.org

and on the website of GNU/Linux
www.linux.org

14.12.2 Samba

The Samba software suite is a collection of programs, which implement the Server Message Block (SMB) protocol for UNIX systems. By using Samba your Lantime is capable of sending Windows popup messages and serves request for network time by clients using the NET TIME command.

The distribution of Samba is covered – like GNU/Linux – by the GNU General Public License, see below.

The website of the Samba project (or a mirror) can be reached at
www.samba.org

14.12.3 Network Time Protocol Version 4 (NTP)

The NTP project, lead by David L. Mills, can be reached in the internet at www.ntp.org. There you will find a wealthy collection of documentation and information covering all aspects of the application of NTP for time synchronization purposes. The distribution and usage of the NTP software is allowed, as long as the following notice is included in our documentation:

```
*****
*
* Copyright (c) David L. Mills 1992-2004
*
* Permission to use, copy, modify, and distribute this software
* and its documentation for any purpose and without fee is hereby
* granted, provided that the above copyright notice appears in all
* copies and that both the copyright notice and this permission
* notice appear in supporting documentation, and that the name
* University of Delaware not be used in advertising or publicity
* pertaining to distribution of the software without specific,
* written prior permission. The University of Delaware makes no
* representations about the suitability this software for any
* purpose. It is provided "as is" without express or implied
* warranty.
*
*****
```

14.12.4 mini_httpd

For our web based configuration tool (HTTP and HTTPS) we use mini_httpd from ACME Labs. The distribution and usage of this program is free provided as long as the following notice appears in the documentation:

Copyright © 2000 by Jef Poskanzer (jef@acme.com). All rights reserved.

Redistribution and use in source and binary forms, with or without modification, are permitted provided that the following conditions are met:

1. Redistributions of source code must retain the above copyright notice, this list of conditions and the following disclaimer.
2. Redistributions in binary form must reproduce the above copyright notice, this list of conditions and the following disclaimer in the documentation and/or other materials provided with the distribution.

THIS SOFTWARE IS PROVIDED BY THE AUTHOR AND CONTRIBUTORS "AS IS" AND ANY EXPRESS OR IMPLIED WARRANTIES, INCLUDING, BUT NOT LIMITED TO, THE IMPLIED WARRANTIES OF MERCHANTABILITY AND FITNESS FOR A PARTICULAR PURPOSE ARE DISCLAIMED. IN NO EVENT SHALL THE AUTHOR OR CONTRIBUTORS BE LIABLE FOR ANY DIRECT, INDIRECT, INCIDENTAL, SPECIAL, EXEMPLARY, OR CONSEQUENTIAL DAMAGES (INCLUDING, BUT NOT LIMITED TO, PROCUREMENT OF SUBSTITUTE GOODS OR SERVICES; LOSS OF USE, DATA, OR PROFITS; OR BUSINESS INTERRUPTION) HOWEVER CAUSED AND ON ANY THEORY OF LIABILITY, WHETHER IN CONTRACT, STRICT LIABILITY, OR TORT (INCLUDING NEGLIGENCE OR OTHERWISE) ARISING IN ANY WAY OUT OF THE USE OF THIS SOFTWARE, EVEN IF ADVISED OF THE POSSIBILITY OF SUCH DAMAGE.

Find out more regarding mini_httpd at the ACME Labs homepage:
www.acme.com

14.12.5 GNU General Public License (GPL)

Version 2, June 1991 - Copyright (C) 1989, 1991

Free Software Foundation, Inc.

675 Mass Ave, Cambridge, MA 02139, USA

Everyone is permitted to copy and distribute verbatim copies of this license document, but changing it is not allowed.

Preamble

The licenses for most software are designed to take away your freedom to share and change it. By contrast, the GNU General Public License is intended to guarantee your freedom to share and change free software—to make sure the software is free for all its users. This General Public License applies to most of the Free Software Foundation's software and to any other program whose authors commit to using it. (Some other Free Software Foundation software is covered by the GNU Library General Public License instead.) You can apply it to your programs, too.

When we speak of free software, we are referring to freedom, not price. Our General Public Licenses are designed to make sure that you have the freedom to distribute copies of free software (and charge for this service if you wish), that you receive source code or can get it if you want it, that you can change the software or use pieces of it in new free programs; and that you know you can do these things.

To protect your rights, we need to make restrictions that forbid anyone to deny you these rights or to ask you to surrender the rights. These restrictions translate to certain responsibilities for you if you distribute copies of the software, or if you modify it.

For example, if you distribute copies of such a program, whether gratis or for a fee, you must give the recipients all the rights that you have. You must make sure that they, too, receive or can get the source code. And you must show them these terms so they know their rights.

We protect your rights with two steps: (1) copyright the software, and (2) offer you this license which gives you legal permission to copy, distribute and/or modify the software.

Also, for each author's protection and ours, we want to make certain that everyone understands that there is no warranty for this free software. If the software is modified by someone else and passed on, we want its recipients to know that what they have is not the original, so that any problems introduced by others will not reflect on the original authors' reputations.

Finally, any free program is threatened constantly by software patents. We wish to avoid the danger that redistributors of a free program will individually obtain patent licenses, in effect making the program proprietary. To prevent this, we have made it clear that any patent must be licensed for everyone's free use or not licensed at all.

The precise terms and conditions for copying, distribution and modification follow.

GNU GENERAL PUBLIC LICENSE TERMS AND CONDITIONS FOR COPYING, DISTRIBUTION AND MODIFICATION

0. This License applies to any program or other work which contains a notice placed by the copyright holder saying it may be distributed under the terms of this General Public License. The "Program", below, refers to any such program or work, and a "work based on the Program" means either the Program or any derivative work under copyright law: that is to say, a work containing the Program or a portion of it, either verbatim or with modifications and/or translated into another language. (Hereinafter, translation is included without limitation in the term "modification".) Each licensee is addressed as "you".

Activities other than copying, distribution and modification are not covered by this License; they are outside its scope. The act of running the Program is not restricted, and the output from the Program is covered only if its contents constitute a work based on the Program (independent of having been made by running the Program). Whether that is true depends on what the Program does.

1. You may copy and distribute verbatim copies of the Program's source code as you receive it, in any medium,

provided that you conspicuously and appropriately publish on each copy an appropriate copyright notice and disclaimer of warranty; keep intact all the notices that refer to this License and to the absence of any warranty; and give any other recipients of the Program a copy of this License along with the Program.

You may charge a fee for the physical act of transferring a copy, and you may at your option offer warranty protection in exchange for a fee.

2. You may modify your copy or copies of the Program or any portion of it, thus forming a work based on the Program, and copy and distribute such modifications or work under the terms of Section 1 above, provided that you also meet all of these conditions:

- a) You must cause the modified files to carry prominent notices stating that you changed the files and the date of any change.
- b) You must cause any work that you distribute or publish, that in whole or in part contains or is derived from the Program or any part thereof, to be licensed as a whole at no charge to all third parties under the terms of this License.
- c) If the modified program normally reads commands interactively when run, you must cause it, when started running for such interactive use in the most ordinary way, to print or display an announcement including an appropriate copyright notice and a notice that there is no warranty (or else, saying that you provide a warranty) and that users may redistribute the program under these conditions, and telling the user how to view a copy of this License. (Exception: if the Program itself is interactive but does not normally print such an announcement, your work based on the Program is not required to print an announcement.)

These requirements apply to the modified work as a whole. If identifiable sections of that work are not derived from the Program, and can be reasonably considered independent and separate works in themselves, then this License, and its terms, do not apply to those sections when you distribute them as separate works. But when you distribute the same sections as part of a whole which is a work based on the Program, the distribution of the whole must be on the terms of this License, whose permissions for other licensees extend to the entire whole, and thus to each and every part regardless of who wrote it.

Thus, it is not the intent of this section to claim rights or contest your rights to work written entirely by you; rather, the intent is to exercise the right to control the distribution of derivative or collective works based on the Program.

In addition, mere aggregation of another work not based on the Program with the Program (or with a work based on the Program) on a volume of a storage or distribution medium does not bring the other work under the scope of this License.

3. You may copy and distribute the Program (or a work based on it, under Section 2) in object code or executable form under the terms of Sections 1 and 2 above provided that you also do one of the following:

- a) Accompany it with the complete corresponding machine-readable source code, which must be distributed under the terms of Sections 1 and 2 above on a medium customarily used for software interchange; or,
- b) Accompany it with a written offer, valid for at least three years, to give any third party, for a charge no more than your cost of physically performing source distribution, a complete machine-readable copy of the corresponding source code, to be distributed under the terms of Sections 1 and 2 above on a medium customarily used for software interchange; or,
- c) Accompany it with the information you received as to the offer to distribute corresponding source code. (This alternative is allowed only for noncommercial distribution and only if you received the program in object code or executable form with such an offer, in accord with Subsection b above.)

The source code for a work means the preferred form of the work for making modifications to it. For an executable work, complete source code means all the source code for all modules it contains, plus any associated interface definition files, plus the scripts used to control compilation and installation of the executable. However, as a special exception, the source code distributed need not include anything that is normally distributed (in either source or binary form) with the major components (compiler, kernel, and so on) of the operating system on which the executable runs, unless that component itself accompanies the executable.

If distribution of executable or object code is made by offering access to copy from a designated place, then offering equivalent access to copy the source code from the same place counts as distribution of the source code, even though third parties are not compelled to copy the source along with the object code.

4. You may not copy, modify, sublicense, or distribute the Program except as expressly provided under this License. Any attempt otherwise to copy, modify, sublicense or distribute the Program is void, and will automatically terminate your rights under this License. However, parties who have received copies, or rights, from you under this License will not have their licenses terminated so long as such parties remain in full compliance.

5. You are not required to accept this License, since you have not signed it. However, nothing else grants you permission to modify or distribute the Program or its derivative works. These actions are prohibited by law if you do not accept this License. Therefore, by modifying or distributing the Program (or any work based on the Program), you indicate your acceptance of this License to do so, and all its terms and conditions for copying, distributing or modifying the Program or works based on it.

6. Each time you redistribute the Program (or any work based on the Program), the recipient automatically receives a license from the original licensor to copy, distribute or modify the Program subject to these terms and conditions. You may not impose any further restrictions on the recipients' exercise of the rights granted herein. You are not responsible for enforcing compliance by third parties to this License.

7. If, as a consequence of a court judgment or allegation of patent infringement or for any other reason (not limited to patent issues), conditions are imposed on you (whether by court order, agreement or otherwise) that contradict the conditions of this License, they do not excuse you from the conditions of this License. If you cannot distribute so as to satisfy simultaneously your obligations under this License and any other pertinent obligations, then as a consequence you may not distribute the Program at all. For example, if a patent license would not permit royalty-free redistribution of the Program by all those who receive copies directly or indirectly through you, then the only way you could satisfy both it and this License would be to refrain entirely from distribution of the Program.

If any portion of this section is held invalid or unenforceable under any particular circumstance, the balance of the section is intended to apply and the section as a whole is intended to apply in other circumstances.

It is not the purpose of this section to induce you to infringe any patents or other property right claims or to contest validity of any such claims; this section has the sole purpose of protecting the integrity of the free software distribution system, which is implemented by public license practices. Many people have made generous contributions to the wide range of software distributed through that system in reliance on consistent application of that system; it is up to the author/donor to decide if he or she is willing to distribute software through any other system and a licensee cannot impose that choice.

This section is intended to make thoroughly clear what is believed to be a consequence of the rest of this License.

8. If the distribution and/or use of the Program is restricted in certain countries either by patents or by copyrighted interfaces, the original copyright holder who places the Program under this License may add an explicit geographical distribution limitation excluding those countries, so that distribution is permitted only in or among countries not thus excluded. In such case, this License incorporates the limitation as if written in the body of this License.

9. The Free Software Foundation may publish revised and/or new versions of the General Public License from time to time. Such new versions will be similar in spirit to the present version, but may differ in detail to address new problems or concerns.

Each version is given a distinguishing version number. If the Program specifies a version number of this License which applies to it and "any later version", you have the option of following the terms and conditions either of that version or of any later version published by the Free Software Foundation. If the Program does not specify a version number of this License, you may choose any version ever published by the Free Software Foundation.

10. If you wish to incorporate parts of the Program into other free programs whose distribution conditions are different, write to the author to ask for permission. For software which is copyrighted by the Free Software Foundation, write to the Free Software Foundation; we sometimes make exceptions for this. Our decision will be guided by the two goals of preserving the free status of all derivatives of our free software and of promoting the sharing and reuse of software generally.

NO WARRANTY

11. BECAUSE THE PROGRAM IS LICENSED FREE OF CHARGE, THERE IS NO WARRANTY FOR THE PROGRAM, TO THE EXTENT PERMITTED BY APPLICABLE LAW. EXCEPT WHEN OTHERWISE STATED IN WRITING THE COPYRIGHT HOLDERS AND/OR OTHER PARTIES PROVIDE THE PROGRAM "AS IS" WITHOUT WARRANTY OF ANY KIND, EITHER EXPRESSED OR IMPLIED, INCLUDING, BUT NOT LIMITED TO, THE IMPLIED WARRANTIES OF MERCHANTABILITY AND FITNESS FOR A PARTICULAR PURPOSE. THE ENTIRE RISK AS TO THE QUALITY AND PERFORMANCE OF THE PROGRAM IS WITH YOU. SHOULD THE PROGRAM PROVE DEFECTIVE, YOU ASSUME THE COST OF ALL NECESSARY SERVICING, REPAIR OR CORRECTION.

12. IN NO EVENT UNLESS REQUIRED BY APPLICABLE LAW OR AGREED TO IN WRITING WILL ANY COPYRIGHT HOLDER, OR ANY OTHER PARTY WHO MAY MODIFY AND/OR REDISTRIBUTE THE PROGRAM AS PERMITTED ABOVE, BE LIABLE TO YOU FOR DAMAGES, INCLUDING ANY GENERAL, SPECIAL, INCIDENTAL OR CONSEQUENTIAL DAMAGES ARISING OUT OF THE USE OR INABILITY TO USE THE PROGRAM (INCLUDING BUT NOT LIMITED TO LOSS OF DATA OR DATA BEING RENDERED INACCURATE OR LOSSES SUSTAINED BY YOU OR THIRD PARTIES OR A FAILURE OF THE PROGRAM TO OPERATE WITH ANY OTHER PROGRAMS), EVEN IF SUCH HOLDER OR OTHER PARTY HAS BEEN ADVISED OF THE POSSIBILITY OF SUCH DAMAGES.

END OF TERMS AND CONDITIONS

14.13 Reference

[Mills88] Mills, D. L., "Network Time Protocol (Version 1) - specification and implementation", DARPA Networking Group Report RFC-1059, University of Delaware, July 1988

[Mills89] Mills, D. L., "Network Time Protocol (Version 2) - specification and implementation", DARPA Networking Group Report RFC-1119, University of Delaware, September 1989

[Mills90] Mills, D. L., "Network Time Protocol (Version 3) - specification, implementation and analysis", Electrical Engineering Department Report 90-6-1, University of Delaware, June 1989

Kardel, Frank, "Gesetzliche Zeit in Rechnernetzen", Funkuhren, Zeitsignale und Normalfrequenzen, Hrsg. W. Hilberg, Verlag Sprache und Technik, Groß-Bieberau 1993

Kardel, Frank, "Verteilte Zeiten", ix Multiuser-Multitasking-Magazin, Heft 2/93, Verlag Heinz Heise, Hannover 1993

Konformitätserklärung

Declaration of Conformity

Hersteller
Manufacturer

Meinberg Funkuhren GmbH & Co. KG
Lange Wand 9
D-31812 Bad Pyrmont

erklärt in alleiniger Verantwortung, daß das Produkt
declares under its sole responsibility, that the product

Produktbezeichnung
Product Name

NTP Timeserver

Modell / Typ
Model Designation

Lantime M200/WWVB

auf das sich diese Erklärung bezieht, mit den folgenden Normen übereinstimmt
to which this declaration relates is in conformity with the following standards

EN55022:1998, Class B
(+A1:2000 +A2:2003)

Grenzwerte und Meßverfahren für Funkstörungen von
informationstechnischen Einrichtungen
Limits and methods of measurement of radio interference characteristics of
information technology equipment

EN55024:1998
(+A1:2001 +A2:2003)

Grenzwerte und Meßverfahren für Störfestigkeit von
informationstechnischen Einrichtungen
Limits and methods of measurement of Immunity characteristics of
information technology equipment

EN 60950-1:2001
(+A11:2004)

Sicherheit von Einrichtungen der Informationstechnik
Safety of information technology equipment

gemäß den Richtlinien 2004/108/EG (Elektromagnetische Verträglichkeit), 2006/95/EG (Nieder-
spannungsrichtlinie) und 93/68/EWG (CE Kennzeichnung) sowie deren Ergänzungen.
following the provisions of the directives 2004/108/EC (electromagnetic compatibility), 2006/95/EC (low voltage directive) and
93/68/EEC (CE marking) and its amendments.

Bad Pyrmont, den 03.07.2009



Günter Meinberg
Managing Director